

# CFORCE 400



## CF400AU CF400AU-L OWNER'S MANUAL

**READ THIS MANUAL CAREFULLY**  
It contains important safety information

This ATV should not be ridden by anyone under 16 years of age. Passenger under 12 are prohibited.  
This ATV is an off-road vehicle.



# TABLE OF CONTENTS

Foreword .....	1
Welcome .....	1
EVAP System (Evaporative Emission Control System) .....	2
Signal Words .....	3
Introduction .....	8
Vehicle Identification Numbers .....	9
Specifications .....	10
Operator Safety .....	16
Safety Training .....	18
Safe Riding Gear .....	44
Safety Decals and Locations .....	45
Features and Controls .....	51
Left Hand Controls .....	51
Right Hand Controls .....	54
Foot Controls .....	59
Vehicle Features .....	62
Operation of Your ATV .....	71
Break-In Period .....	71
Pre-Ride Inspection.....	73
Starting the Engine .....	74

Gear Selector Operation .....	76
Hauling and Towing Cargo .....	79
Load Distribution .....	81
Driving Safely .....	82
Maintenance .....	99
Severe Use Definition .....	99
Periodic Maintenance Schedule and Icon Key .....	100
Maintenance Procedures .....	110
Cleaning and Storage .....	152
Washing the vehicle .....	152
Waxing the vehicle .....	153
Perform repairs .....	153
Check the tires .....	153
Oil and filter .....	153
Air filter/ Air box .....	153
Check fluid levels .....	154
Stabilize the fuel .....	154
Battery storage .....	154
Lubricate .....	154
'Fog' the engine .....	155
Storage area and covering .....	156

Transporting the vehicle .....	156
Vehicle Issue Diagnosis .....	157
Engine doesn't turn over .....	157
Engine pings or knocks .....	157
Engine stops or loses power .....	158
Engine turns over, Fails to start.....	159
Engine backfires .....	160
Engine runs irregularly, stalls or misfires .....	160
EFI Malfunction Indicator Light .....	162
Change of Ownership .....	163
CFMOTO Limited Warranty .....	164
WARRANTY TERMS & CONDITIONS .....	164
U.S.A. EPA and CARB Emissions Control Limited Warranty .....	170
Noise Control System and Tampering .....	174

## **Foreword**

### **Welcome**

Thank you for purchasing a CFMOTO vehicle, and welcome to our world-wide family of CFMOTO enthusiasts. Be sure to visit us online at [www.cfmoto.com](http://www.cfmoto.com) for the latest news, new product introductions, upcoming events, career opportunities, and more.

CFMOTO develops, manufactures, markets and delivers the world's most reliable and cost-effective all-terrain vehicles, motorcycles and scooters, utility vehicles, boat and power sports engines. Founded in 1989 and teaming up with more than 1200 companions, CFMOTO has developed 98 vehicle models and 51 engine models, which are distributed in over 70 countries and regions. CFMOTO is edging into the advanced ranks in the world in the power sports industry, and aims to supply superior products to dealers and fans globally.

For safe and enjoyable operation of your vehicle, be sure to follow the instructions and recommendations in this owner's manual. Your manual contains instructions for minor maintenance. Information about major repairs is outlined in the CFMOTO Service Manual. Your CFMOTO dealer knows your vehicle best and is interested in your total satisfaction. Be sure to return to your dealership for all of your service needs during, and after, the warranty period.

## FOREWORD

### **WARNING**

The engine exhaust from this product contains chemicals known to the State of California to cause cancer, birth defects or other reproductive harm.

### **EVAP System (Evaporative Emission Control System)**

Do not modify the EVAP system. Modification is a violation of EPA regulations. Ensure that all the hoses are not clogged or kinked, otherwise it could damage the fuel pump or distort the fuel tank.

### **NOTE**

Some features described within this manual may not apply to models sold in the U.S.  
All descriptions and directions given are from the operator's perspective when seated on the vehicle.

## FOREWORD

### Signal Words

A signal word calls attention to a safety message or messages, a property damage message or messages, and designates a degree or level of hazard seriousness. The standard signal words in this manual are WARNING, CAUTION and NOTE or NOTICE.

The following signal words and symbols appear throughout this manual and on your vehicle. Your safety is involved when these words and symbols are used. Become familiar with their meanings before reading the manual:

#### **WARNING**

This safety alert and icon indicates a potential hazard that may result in serious injury or death.

#### **CAUTION**

This safety alert and icon indicates a potential hazard that may result in minor or moderate personal injury and/or damage to the vehicle.

#### **CAUTION**

This safety alert without an icon indicates a situation that may result in damage to the vehicle.

#### **NOTE or NOTICE**

A note or notice will alert you to important information or instructions

**FOREWORD**  
**⚠️ WARNING FOR TYPE I ATVs**  
**(1-person vehicle)**

**Improper vehicle use can result in SEVERE INJURY or DEATH**



**ALWAYS  
USE AN  
APPROVED  
HELMET AND  
PROTECTIVE  
GEAR**



**NEVER USE  
ON PUBLIC  
ROADS**



**NEVER CARRY  
PASSENGERS**



**NEVER  
USE WITH  
DRUGS OR  
ALCOHOL**



**FOREWORD**  
**⚠️ WARNING FOR TYPE II ATVs**  
**(2-person vehicle)**

**Improper vehicle use can result in SEVERE INJURY or DEATH**



**ALWAYS  
USE AN  
APPROVED  
HELMET AND  
PROTECTIVE  
GEAR**



**NEVER USE  
ON PUBLIC  
ROADS**



**NEVER  
CARRY MORE  
THAN ONE  
PASSENGER**



**NEVER  
USE WITH  
DRUGS OR  
ALCOHOL**

## **FOREWORD**

### **NEVER:**

- Operate without proper training or instruction.
- Operate on public roads. A collision can occur with another vehicle.
- Operate at speeds too fast for your skill or the conditions.
- Carry multiple passengers, Type II ATVs are designed for a single passenger only.
- Use ALCOHOL or DRUGS before or while driving this vehicle.

### **ALWAYS:**

- Avoid paved surfaces, which may adversely affect the handling and control.
- Use proper riding techniques to avoid vehicle overturn on hills and rough terrain, and when turning.
- Wear eye protection, helmet and protective clothing.

**FOREWORD**  
**READ THE OWNER'S MANUAL**

**FOLLOW ALL INSTRUCTIONS AND WARNINGS**

 **WARNING**

Read, understand, and follow all of the instructions and safety precautions in this manual and on all product labels. Failure to follow the safety precautions could result in serious injury or death.

 **WARNING**

The engine exhaust gas from this product contains carbon monoxide, which is a deadly gas and could cause headaches, giddiness, loss of consciousness, or even death.

## Introduction

Thank you for purchasing a CFMOTO vehicle, and welcome to our worldwide family of CFMOTO owners. We proudly produce an exciting line of utility and recreational products:

- All-terrain vehicles (ATV).
- Utility and Side-by-Side vehicles (patrol, forest protecting and hunting).
- Motorcycles and scooters.

CFMOTO, a company which specializes in production of liquid-cooled engines, is the top-level supplier in China. Compared to same displacement air-cooled engines, engine cooling is more effective, oil temperature is more stable, the engine is more powerful with lower fuel consumption, and has a longer working life.

For safe and enjoyable operation of your vehicle, be sure to follow the instructions and recommendations in this owner's manual. Your manual contains instructions for minor maintenance. Information about major repairs are outlined in the CFMOTO service manual, and should be performed only by a CFMOTO service dealer and technician. Your CFMOTO dealer knows your vehicle best and is interested in your total satisfaction. Be sure to return to your dealership for all of your service.

Due to constant improvements in the design and quality of production components, some minor discrepancies may result between the actual vehicle and the information presented in this publication. Depictions and/or procedures in this publication are intended for reference use only. The most current version of this manual can be found online at [www.cfmoto.com](http://www.cfmoto.com).

## INTRODUCTION

### Vehicle Identification Numbers

Record your vehicle's identification numbers in the spaces provided. Remove the spare key and store in a safe place. Your key can be duplicated only by mating a key blank with one of your existing keys.

If both keys are lost, the complete lock assembly must be replaced.

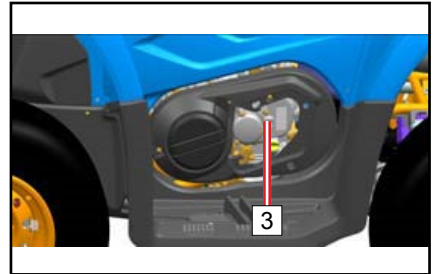
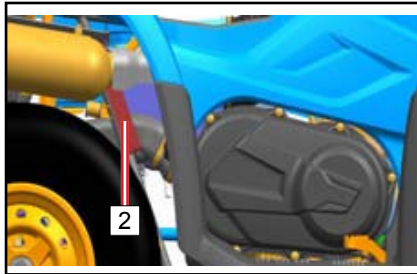
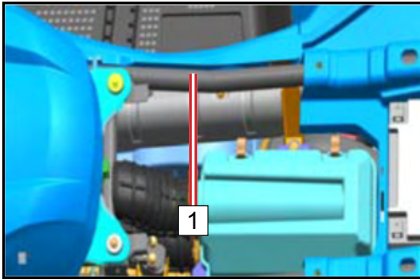

- 1 Vehicle Identification Number: \_\_\_\_\_
- 2 Vehicle Model Number: \_\_\_\_\_
- 3 Engine Serial Number: \_\_\_\_\_

## INTRODUCTION

### Specifications

Item	Specification	
	CF400AU	CF400AU-L
Vehicle Type	1-person	2-person
Overall Length	82.7 in. (2100 mm)	90.5 in (2300 mm)
Overall Width	43.3 in (1100 mm)	43.3 in (1100 mm)
Overall Height	45.3 in. (1150 mm)	53.1 in. (1350 mm)
Wheel Base	49.6 in. (1260 mm)	57.5 in. (1460 mm)
Minimum ground clearance	9.8 in. (250 mm)	9.8 in. (250 mm)
Min. turning radius	137.8 in. (3500 mm)	137.8 in. (3500 mm)
Basic weight: ( Engine oil and fuel tank full)	760.5 lb. (345 kg)	793.6 lb. (360 kg)
Front rack weight capacity	44 lbs. (20 kg)	
Rear rack weight capacity	88 lbs. (40 kg)	
Recommended towing capacities:		
Tongue weight	66 lbs. (30 kg)	
Trailer and Cargo weight	330 lbs. (150 kg)	
Engine model	191Q	

## INTRODUCTION

Item	Specification	
	CF400AU	CF400AU-L
Engine type	Liquid-cooled/4-stroke, overhead single camshaft	
Bore × Stroke	3.58 in x 2.42 in (91 mm x 61.5 mm)	
Displacement	400 cc	
Compression ratio	10.3 : 1	
Starting type	Electric start	
Lubrication type	Splash /pressure feed	
Engine oil: Type:	SAE 5W-40/SG	
Engine oil volume: Capacity change / no oil filter	2.4 qt. (2.27L)	
Capacity change / oil filter	3.0 qt. (2.83L)	
Rear gear case oil: Type Volume	SAE80W/90 GL-5 8.5 oz. (250mL)	

## INTRODUCTION

Item		Specification	
		CF400AU	CF400AU-L
Front gear case oil: Type Volume		SAE80W/90 GL-5 7.8 oz. (230mL)	
Air filter		Paper filter element with foam pre-filter	
Fuel type Fuel tank capacity Fuel reserve amount		89 Octane or higher unleaded gasoline 3.75 gallons (14.1L) 4.1 qt. (3.88L)	
Spark plug: type Spark plug gap		DCPR8E (NGK) 0.035 in. ~ 0.045 in. (0.8 mm~0.9 mm)	
Transmission	Transmission	CVT + Gear shift	
	Gear shift/order	Manual / L-H-N-R-P	
	CVT ratio	0.67~3.02	
	Low Gear	38/15=2.533	



## INTRODUCTION

Item			Specification	
			CF400AU	CF400AU-L
	Gear ratio	High Gear	27/20=1.350	
		Reverse	29/14=2.071	
Chassis Frame			Steel tube	
Caster angle			3°	
Kingpin offset			27.97mm	
Tires: Type			Tubeless	
Size	Front		24×8.0-12	
	Rear		24×10.0-12	
Tire pressure:			8 psi (56kPa)	
Front			6 psi ~6.5 psi (41.3 kPa ~44.8 kPa)	
Rear				
Brake system:			Front axles: Double-disc / Rear axles: Single-disc	

## INTRODUCTION

Item	Specification	
	CF400AU	CF400AU-L
Foot brake      Type Operation	Operated by right foot	
	Double-disc	
Front brake      Type	Operated by right hand	
Brake Fluid Type	DOT 4	
Suspension: Front suspension Rear suspension	Double A-arm independent Double A-arm independent	
Shock absorber: Front shock absorber Rear shock absorber	Coil spring/Oil dampened Coil spring/Oil dampened	

## INTRODUCTION

Item	Specification	
	CF400AU	CF400AU-L
Wheel travel: Front wheel travel Rear wheel travel	7.08 in. (180 mm) 7.08 in. (180 mm)	
Electrical system: Ignition Charging Battery	Electronic Rectified A/C magneto 320Watt@5000 rpm 12Vdc / 30 Amp/hr	
Light system: Head lamp type Tail light/Brake light License plate light	Halogen -HS1 35W×2 Incandescent - 12V 21/5Wx1 Incandescent - 5Wx1	

## Operator Safety

### **WARNING**

Failure to heed the warnings contained in this manual can result in serious injury or death. An ATV is not a toy and can be hazardous to operate. This vehicle handles differently from other vehicles, such as motorcycles and cars. A collision or rollover can occur quickly, even during routine maneuvers like turning or driving over obstacles, if you fail to take proper precautions.

Read this owner's manual. Understand all safety warnings, precautions and operating procedures before operating this vehicle.

A packet containing important ATV safety information should be present with the owner's manual. If you cannot locate this packet, or if it has been removed, please contact your dealer.

### **Age Restrictions**

This vehicle is an ADULT VEHICLE ONLY. Operation is prohibited for anyone under the age of 16. No passengers are allowed on CFMOTO vehicles designed for single person operation.

### **Know Your Vehicle**

As the operator of the vehicle, you are responsible for your personal safety, the safety of others, and the protection of the environment. Read and understand your owner's manual, which includes valuable information about all aspects of your vehicle, including safe operating procedures.

## **SAFETY**

### **Equipment Modifications**

CFMOTO is concerned with the safety of our customers and for the general public. Therefore, we strongly recommend that consumers do not install on a vehicle, any equipment that may increase the speed or power of the vehicle, or make any other modifications to the vehicle for these purposes. Any modifications to the original equipment of the vehicle create a substantial safety hazard and increase the risk of body injury. The warranty on your vehicle is terminated if any unapproved accessory equipment has been added to the vehicle, or if any modifications have been made to the vehicle that increase its speed or power.

### **NOTE**

The addition of certain accessory equipment which may change the handling and performance characteristics of the vehicle include, but are not limited to; mowers, plow blades, oversize tires, sprayers, large racks, lift kits and trailers. Use only approved accessories, and familiarize yourself with their function and effect on the vehicle.

## **SAFETY**

### **Safety Training**

When you purchased your ATV, your dealer offered a hands-on safety training course that covers all aspects of vehicle safety. You were also provided with printed materials that explain safe operating procedures. You should review this information on a regular basis. If you purchased a used ATV from a party other than a dealer, you can request safety training from any authorized dealer. Familiarize yourself with all laws and regulations concerning the operation of ATVs in your area. CFMOTO strongly advises you to strictly follow the recommended maintenance program outlined in your owner's manual. This preventive maintenance program is designed to ensure that all critical components on your vehicle are thoroughly inspected and serviced at specific intervals for safety.

### **Hazardous Operation Warnings**

Serious injury or death can result if you do not follow the following instructions and procedures outlined in further detail within your owner's manual:

#### **WARNING**

- Read this manual and all labels carefully, and follow the operating procedures described.
- Never operate an ATV without proper instruction. Take a training course. Beginners should receive training from a certified instructor. Contact an authorized dealer to find out about the training courses nearest you.
- Never allow anyone under 16 years of age to operate the vehicle.
- Never permit a guest to operate the ATV unless the guest has read this manual, all product labels, and has completed a certified safety training course.

## **SAFETY**

- Never operate an ATV without wearing an approved helmet that fits properly. Always wear eye protection (goggles or face shield), gloves, boots, a long-sleeved shirt or jacket, and long pants.
- Never consume alcohol or drugs before or while operating an ATV.
- Never operate at excessive speeds. Travel at speeds appropriate for the terrain, visibility, operating conditions, and your experience.
- Never attempt wheelies, jumps, or other stunts.
- Always inspect your ATV before each use to make sure it's in safe operating condition.
- Always follow the inspection schedules and maintenance outlined in your owner's manual.
- Always keep both hands on the handlebars and both feet on the foot-rests of the ATV during operation.
- Always travel slowly and use extra caution when operating on unfamiliar terrain.
- Never operate on excessively rough, slippery, or loose terrain.
- Always follow proper turning procedures as described in this manual. Practice turning at low speeds before attempting to turn at faster speeds. Do not turn at excessive speeds.
- Always have the ATV inspected by an authorized dealer if it's been involved in an accident.
- Never operate on hills too steep for the ATV or for your abilities. Practice on smaller hills before attempting larger hills.
- Always follow proper procedures for climbing hills:
  - Check the terrain carefully before ascending a hill.
  - Never climb hills with excessively slippery or loose surfaces.
  - Shift your weight forward.
  - Never open the throttle suddenly or make sudden gear changes.
  - Never go over the top of a hill at high speed.

## **SAFETY**

- Always follow proper procedures for going downhill and for braking on hills:
  - Check the terrain carefully before you start down a hill.
  - Shift your weight backward.
  - Never travel down a hill at high speed.
  - Avoid travel down a hill at an angle, which would cause the vehicle to lean sharply to one side.
  - Travel straight down the hill when possible.
- Always follow proper procedures for crossing the side of a hill:
  - Avoid hills with excessively slippery or loose surfaces.
  - Shift your weight to the uphill side of the ATV.
  - Never attempt to turn the ATV around on any hill until you have mastered (on level ground) the turning technique outlined in this manual.
  - Avoid crossing the side of a steep hill when possible.
- Always use proper procedures if you stall or roll backwards while climbing a hill:
  - To avoid stalling, maintain a steady speed when climbing a hill.
  - If you stall or roll backwards, follow the special procedure for braking described in this manual.
  - Always dismount on the uphill side, or to either side if the ATV is pointed straight uphill.
  - Turn the ATV around and remount following the procedure described in this manual.
- Always check for obstacles before operating in a new area. Never attempt to operate over large obstacles, such as rocks or fallen trees. Always follow proper procedures when operating over obstacles as described in this manual.
- Always be careful of skidding or sliding. On slippery surfaces like ice, travel slowly and use extra caution to reduce the chance of skidding or sliding out of control.



## **SAFETY**

- Avoid operating the ATV through deep or fast-flowing water. If it's unavoidable, travel slowly, balance your weight carefully, avoid sudden movements, and maintain a slow and steady forward motion. Do not make sudden turns or stops, and do not make sudden throttle changes.
- Wet brakes may have reduced stopping ability. Test your brakes after leaving water. If necessary, apply them lightly several times to allow friction to dry out the pads.
- Always check for obstacles or people behind the ATV before operating in reverse. When it's safe to proceed in reverse, move slowly and avoid turning at sharp angles.
- Always use the size and type of tires specified for your ATV, and always maintain proper tire pressure.
- Never modify an ATV through improper installation or use of accessories.
- Never exceed the stated load capacity for your ATV. Cargo must be properly distributed and securely attached. Reduce speed and follow the instructions in this manual for carrying cargo or towing. Allow a greater distance for braking.
- Always remove the ignition key when the vehicle is not in use to prevent unauthorized use or accidental starting.
- Children or pets shall not be carried on the racks.
- Never touch moving parts such as wheels, drive shafts, etc.

**FOR MORE INFORMATION ABOUT ATV SAFETY, PLEASE CONTACT YOUR DEALER.**

## **SAFETY**

### **WARNING**

#### **POTENTIAL HAZARD:**

Operating this ATV without proper instruction.

#### **WHAT CAN HAPPEN:**

The risk of an accident is greatly increased if the operator does not know how to operate the ATV properly in different situations and on different types of terrain.

#### **HOW TO AVOID THE HAZARD:**

Beginning and inexperienced operator should complete the certified training course offered by dealer. Operators should regularly practice the skills learned in the course and the operating techniques described in the owner's manual.

## **SAFETY**

### **WARNING**

#### **POTENTIAL HAZARD:**

Failure to follow the age recommendations for this ATV.

#### **WHAT CAN HAPPEN:**

Severe injury and/or death could occur if a child under the minimum age recommendation operates an ATV.

Even though a child may be within the recommended age group for operating some ATVs, he/she may not have the skills, abilities, or judgment needed to operate an ATV safely and could be susceptible to accident or injury.

#### **HOW TO AVOID THE HAZARD:**

Operation is prohibited for anyone under 16 years of age.

## SAFETY

### **⚠️ WARNING**

#### **POTENTIAL HAZARD:**

Carrying a passenger on an ATV that is not designed for carrying a passenger.

#### **WHAT CAN HAPPEN:**

A passenger riding on the ATV could be ejected from the vehicle unexpectedly or make contact with moving components, both of which can result in severe injury or death.

#### **HOW TO AVOID THE HAZARD:**

Never allow a passenger on an ATV that is not designed for carrying a passenger.

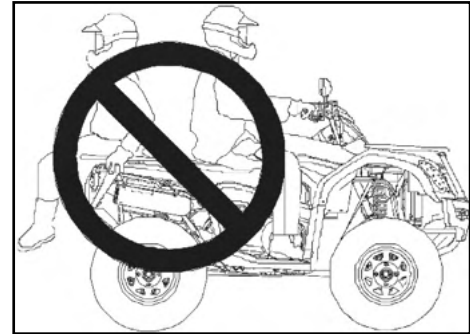

## SAFETY

### **⚠️ WARNING**

#### **POTENTIAL HAZARD:**

Operation on paved surfaces such as sidewalks, trails parking lots, or public highways and streets.

#### **WHAT CAN HAPPEN:**

ATV tires are designed for off-road use. Driving on paved surfaces greatly affects how an ATV handles, which can result in loss of control and/or an accident.

#### **HOW TO AVOID THE HAZARD:**

Never drive on paved surfaces. If it is unavoidable, slow down and do not make sudden turning or braking maneuvers.

Never operate ATVs on public highways or streets if it is not allowed by law. Check local laws to determine if it is legal to do so.

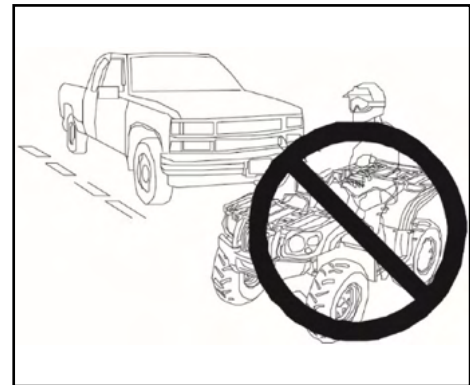
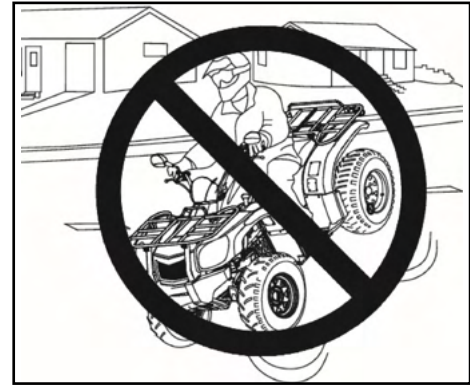

## SAFETY

### **⚠️ WARNING**

#### **POTENTIAL HAZARD:**

Operating this ATV without wearing an approved helmet, eye protection, and protective clothing.

#### **WHAT CAN HAPPEN:**

Operating an ATV without an approved helmet increases the risk of a severe head injury or death in the event of an accident. Operating without eye protection could result in an accident and could increase the chance of a severe eye injury in the event of an accident. Operating without protective clothing could increase the chance of a severe injury.

#### **HOW TO AVOID THE HAZARD:**

Always wear an approved helmet that fits properly. Always wear eye protection (goggles or face shield), gloves, long-sleeved shirt or jacket, and long pants.



## SAFETY

### **⚠️ WARNING**

#### **POTENTIAL HAZARD:**

Operating the ATV after consuming alcohol or drugs.

#### **WHAT CAN HAPPEN:**

Consumption of alcohol and/or drugs could seriously affect operator judgment. Reaction time may be slower and operator balance and perception could be affected. Consumption of alcohol and/or drugs before or while operating an ATV could result in an accident causing severe injury or death.

#### **HOW TO AVOID THE HAZARD:**

Never consume alcohol or drugs before or while operating an ATV.



## SAFETY

### **⚠️ WARNING**

#### **POTENTIAL HAZARD:**

Operating the ATV at excessive speeds.

#### **WHAT CAN HAPPEN:**

Excessive speed increases the operator's chance of losing control of the ATV, which can result in an accident.

#### **HOW TO AVOID THE HAZARD:**

Always operate the ATV at a speed that's proper for the terrain, visibility and operating conditions, and your experience.

### **⚠️ WARNING**

#### **POTENTIAL HAZARD:**

Attempting wheelies, jumps and other stunts.

#### **WHAT CAN HAPPEN:**

Attempting stunts increases the chance of an accident, including an overturn.

#### **HOW TO AVOID THE HAZARD:**

Never attempt wheelies, jumps, or other stunts. Avoid exhibition driving.

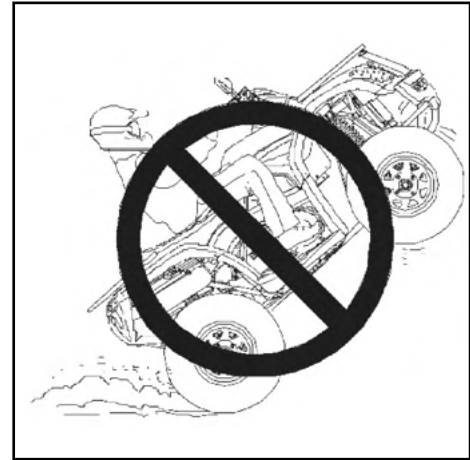



## SAFETY

### **WARNING**

#### **POTENTIAL HAZARD:**

Failure to inspect the ATV before operating. Failure to properly maintain the ATV.

#### **WHAT CAN HAPPEN:**

Poor maintenance increases the possibility of an accident or equipment damage.

#### **HOW TO AVOID THE HAZARD:**

Always inspect your ATV before each use to make sure it's in safe operating condition.

Always follow the inspection and maintenance procedures and schedules described in the owner's manual.

## **SAFETY**

### **WARNING**

#### **POTENTIAL HAZARD:**

Removing hands from the handlebars or feet from the footrests during operation.

#### **WHAT CAN HAPPEN:**

Removing even one hand or foot can reduce ability to control the vehicle or could cause loss of balance and ejection from the ATV.

If the operator's foot is not firmly planted on the footrest, it could come into contact with the rear wheels and lead to an accident or injury.

#### **HOW TO AVOID THE HAZARD:**

Always keep both hands on the handlebars and both feet on the footrests of the ATV during operation.

## SAFETY

### **⚠️ WARNING**

#### **POTENTIAL HAZARD:**

Failure to use extra caution when operating the ATV on unfamiliar terrain.

#### **WHAT CAN HAPPEN:**

Unfamiliar terrain may contain hidden rocks, bumps, or holes that could cause loss of control or overturn.

#### **HOW TO AVOID THE HAZARD:**

Travel slowly and use extra caution when operating on unfamiliar terrain. Always be alert to changing terrain conditions.



## SAFETY

### **⚠️ WARNING**

#### **POTENTIAL HAZARD:**

Failure to use extra caution when operating on excessively rough, slippery or loose terrain.

#### **WHAT CAN HAPPEN:**

Operating on excessively rough, slippery or loose terrain could cause loss of traction or loss of control, which could result in an accident or overturn.

#### **HOW TO AVOID THE HAZARD:**

Do not operate on excessively rough, slippery or loose terrain until you've learned and practiced the skills necessary to control the ATV on such terrain. Always use extra caution on rough, slippery or loose terrain.



### **⚠️ WARNING**

#### **POTENTIAL HAZARD:**

Turning improperly.

#### **WHAT CAN HAPPEN:**

Improper turns could cause loss of control and lead to a collision or overturn.

#### **HOW TO AVOID THE HAZARD:**

Always follow proper procedures for turning as described in the owner's manual. Practice turning at slow speeds before attempting to turn at faster speeds. Never turn at excessive speed.

## SAFETY

### **⚠️ WARNING**

#### **POTENTIAL HAZARD:**

Climbing excessively steep hills or climbing hills improperly.

#### **WHAT CAN HAPPEN:**

Improper hill climbing could cause loss of control or overturn.

#### **HOW TO AVOID THE HAZARD:**

Never operate on hills too steep for the ATV or for your abilities. Practice on smaller hills before attempting large hills. Always check the terrain carefully before ascending any hill. Never climb hills with excessively slippery or loose surfaces. Shift your weight forward. Never open the throttle suddenly while traveling uphill. The ATV could flip over backwards. Never go over the top of any hill at high speed. An obstacle, a sharp drop, or another vehicle or person could be on the other side of the hill.



## SAFETY

### **⚠️ WARNING**

#### **POTENTIAL HAZARD:**

Traveling down excessively steep hills.

#### **WHAT CAN HAPPEN:**

Improper downhill travel could cause loss of control or overturn.

#### **HOW TO AVOID THE HAZARD:**

Never operate on hills too steep for the ATV or for your abilities. Practice on smaller hills before attempting large hills. Always check the terrain carefully before attempting any hill. Never descend hills with excessively slippery or loose surfaces.

#### **NOTE**

A special driving and braking technique is required while traveling downhill. Always check the terrain carefully before descending a hill. Shift your weight backward. Never travel down a hill at high speed. Avoid traveling down a hill at an angle, which would cause the vehicle to lean sharply to one side. Travel straight down the hill when possible.



## SAFETY

### **⚠️ WARNING**

#### **POTENTIAL HAZARD:**

Improperly crossing hills and turning on hills

#### **WHAT CAN HAPPEN:**

Improperly crossing or turning on hills could cause loss of control or overturn.

#### **HOW TO AVOID THE HAZARD:**

Never attempt to turn the ATV around on any hill until you've mastered the turning technique on level ground as described in the owner's manual.

Use extra caution when turning on any hill. Avoid crossing the side of a steep hill.

#### **WHEN CROSSING THE SIDE OF A HILL:**

Always follow proper procedures as described in the owner's manual. Avoid hills with excessively slippery or loose surfaces. Shift your weight to the uphill side of the ATV.



## SAFETY

### **⚠️ WARNING**

#### **POTENTIAL HAZARD:**

Stalling, rolling backwards or improperly dismounting while climbing a hill.

#### **WHAT CAN HAPPEN:**

The vehicle could overturn.

#### **HOW TO AVOID THE HAZARD:**

Maintain a steady speed when climbing a hill.

#### **IF ALL FORWARD SPEED IS LOST:**

Close the throttle. Keep your weight uphill. Apply the front brake. When fully stopped, apply the foot brake as well, then shift the gear selector to the park position.

#### **IF THE ATV BEGINS ROLLING:**

Keep weight uphill. Never apply engine power. Never apply the foot brake while rolling backwards. Apply the front brake. When fully stopped, apply the foot brake and shift the gear selector to the parking position. Dismount on uphill side, or to either side if ATV is pointed straight uphill.

Turn the ATV around and remount, following the procedure described in the owner's manual.





## **SAFETY**

### **WARNING**

#### **POTENTIAL HAZARD:**

Improperly operating over obstacles.

#### **WHAT CAN HAPPEN:**

Operating over obstacles could cause loss of control or overturn.

#### **HOW TO AVOID THE HAZARD:**

Before operating in a new area, check for obstacles. Avoid operating over large obstacles such as rocks and fallen trees when possible. If unavoidable, use extreme caution and always follow proper procedures as outlined in the owner's manual.

## SAFETY

### **WARNING**

#### **POTENTIAL HAZARD:**

Skidding or sliding.

#### **WHAT CAN HAPPEN:**

Skidding or sliding can cause loss of control. If the tires regain traction unexpectedly, the ATV could overturn.

#### **HOW TO AVOID THE HAZARD:**

On slippery surfaces such as ice, travel slowly and use extra caution to reduce the chance of skidding or sliding out of control.

### **WARNING**

#### **POTENTIAL HAZARD:**

Overloading the ATV or carrying/towing cargo improperly.

#### **WHAT CAN HAPPEN:**

Overloading and towing can cause changes in vehicle handling, which could lead to loss of control or an accident.

#### **HOW TO AVOID THE HAZARD:**

Never exceed the stated load capacity for this ATV.

Cargo should be properly distributed and securely attached. Reduce speed when carrying cargo or pulling a trailer. Allow a greater distance for braking. Always follow the instructions in the owner's manual for carrying cargo or pulling a trailer.

## SAFETY

### **WARNING**

#### **POTENTIAL HAZARD:**

Operation of the ATV through deep or fast-flowing water.

#### **WHAT CAN HAPPEN:**

The tires may float, causing loss of traction and loss of control, which can lead to an accident or overturn.

#### **HOW TO AVOID THE HAZARD:**

Avoid operating the ATV through deep or fast-flowing water. If it is unavoidable to enter water that exceeds the recommended maximum depth, travel slowly, balance your weight carefully, avoid sudden movements, and maintain a slow and steady forward motion. Do not make sudden turns or stops, and do not make sudden throttle changes. Wet brakes may have reduced stopping ability. Always test the brakes after leaving the water. If necessary, apply brakes several times to dry out the pads.

## SAFETY

### **WARNING**

#### **POTENTIAL HAZARD:**

Improperly operating in reverse.

#### **WHAT CAN HAPPEN:**

The ATV could collide with an obstacle or person, resulting in severe injury.

#### **HOW TO AVOID THE HAZARD:**

Before shifting into reverse gear, always check for obstacles or people behind the ATV. When it's safe to proceed, back slowly.

### **WARNING**

#### **POTENTIAL HAZARD:**

Operating this ATV with improper tires, or with improper or uneven tire pressure.

#### **WHAT CAN HAPPEN:**

Use of improper tires, or operation of the ATV with improper or uneven tire pressure, could cause loss of control or an accident.

#### **HOW TO AVOID THE HAZARD:**

Always use the size and type of tires specified in the owner's manual for the ATV. Always maintain proper tire pressure.

## SAFETY

### **WARNING**

#### **POTENTIAL HAZARD:**

Operating the ATV with improper modifications.

#### **WHAT CAN HAPPEN:**

Improper installation of accessories or modification of the ATV may cause changes in handling which could lead to an accident.

#### **HOW TO AVOID THE HAZARD:**

Never modify the ATV through improper installation or use of accessories. All parts and accessories added to the vehicle must be genuine parts or equivalent components designed for use on this ATV and should be installed and used according to approved instructions. Consult your dealer for more information.

## SAFETY

### **WARNING**

#### **POTENTIAL HAZARD:**

Operating on frozen bodies of water.

#### **WHAT CAN HAPPEN:**

Severe injury or death can result if the ATV and/or the operator fall through the ice.

#### **HOW TO AVOID THE HAZARD:**

Never operate the ATV on a frozen body of water.

## **SAFETY**

### **⚠️ WARNING**

Leaving the keys in the ignition can lead to unauthorized use of the vehicle, resulting in serious injury or death. Always remove the ignition key when the vehicle is not in use.

### **⚠️ WARNING**

After any overturn or accident, have a qualified service dealer inspect the entire vehicle for possible damage, including (but not limited to) brakes, throttle and steering systems.

### **⚠️ WARNING**

Safe operation of this rider-active vehicle requires good judgment and physical skills. Persons with cognitive or physical disabilities who operate this vehicle have an increased risk of overturn and loss of control, which could result in severe injury or death.

### **⚠️ WARNING**

Exhaust system components are very hot during and after use of the vehicle. Hot components can cause serious burns and fire. Do not touch hot exhaust system components. Always keep combustible materials away from the exhaust system. Use caution when traveling through tall grass, especially dry grass.

## SAFETY

### Safe Riding Gear

Always wear clothing suited to the type of riding. ATV riding requires special protective clothing for comfort and to reduce the chance of injury:

1. Helmet
2. Your helmet is the most important piece of protective gear for safe riding. An approved helmet can prevent a severe head injury.
3. Eye protection
4. Do not depend on sunglasses for proper eye protection. A pair of goggles or a helmet face shield offers the best protection for your eyes. They should be kept clean and be a shatterproof design.
5. Gloves
6. Off-road style gloves with knuckle pads are the best for comfort and protection.
7. Boots
8. The best footwear is a pair of strong over-the-calf boots with heels, like moto-cross boots.
9. Clothing
10. Always wear long sleeves and long pants to protect arms and legs. Riding pants with kneepads and a jersey with shoulder pads provide the best protection.

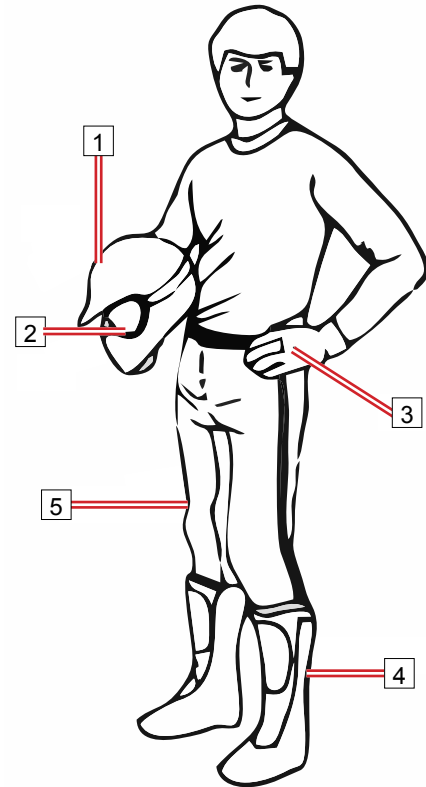



## Safety Decals and Locations

Warning decals have been placed on the ATV for your protection. Read and follow the instructions on each decal carefully. If a decal becomes illegible or comes off, contact your dealer to purchase a replacement.

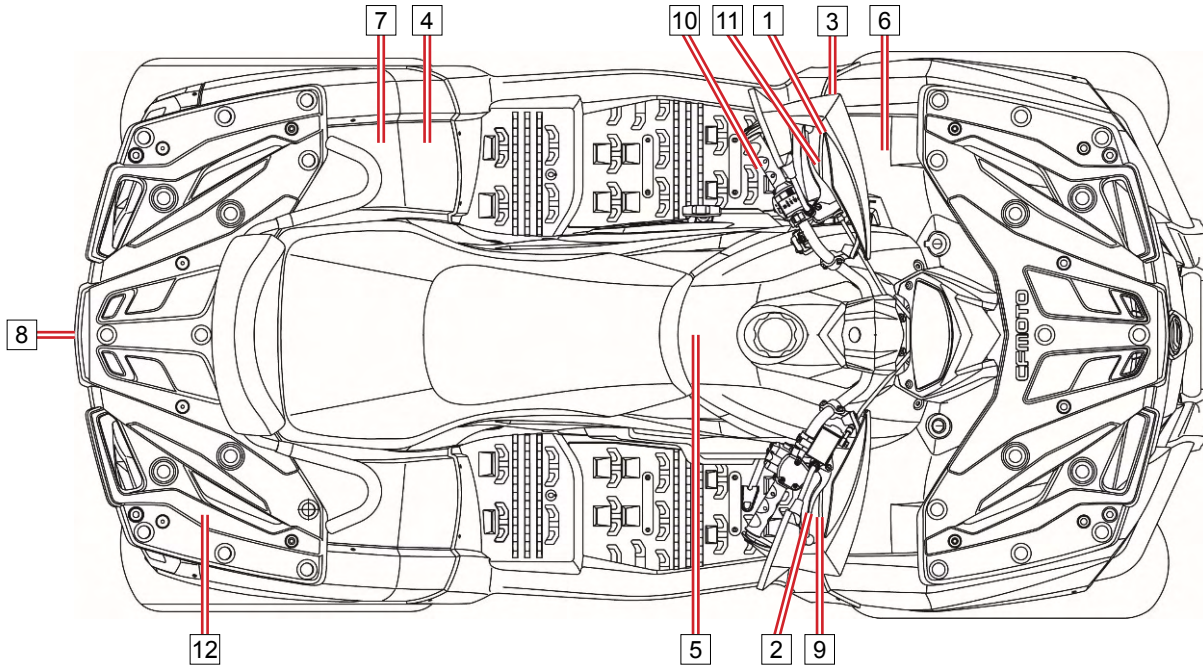

## SAFETY DECALS AND LOCATIONS

1



TYPE I



TYPE II

## SAFETY DECALS AND LOCATIONS

2

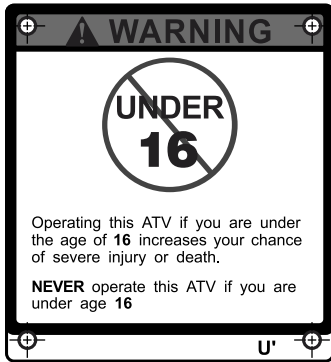

TYPE I



TYPE II

3



TYPE I

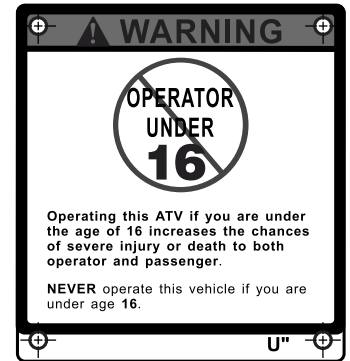

TYPE II

## SAFETY DECALS AND LOCATIONS

4

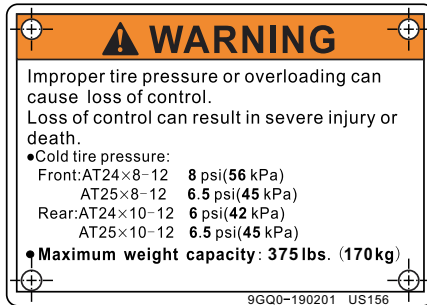

TYPE I

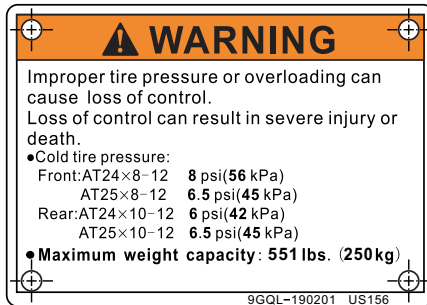

TYPE II

5



## SAFETY DECALS AND LOCATIONS

6



TYPE I

7



TYPE I



TYPE II



TYPE II

8

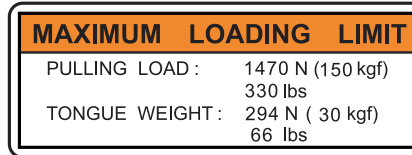

## SAFETY DECALS AND LOCATIONS

9

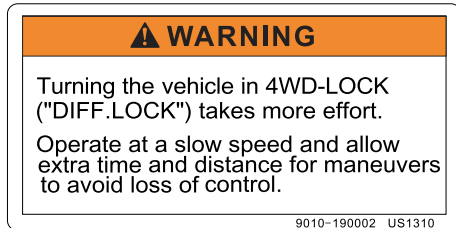

10

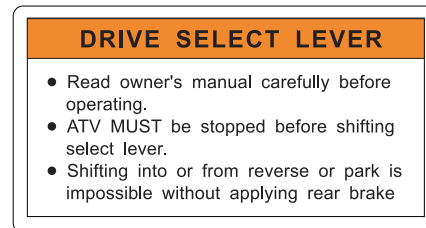

10 (Only for USA)

11

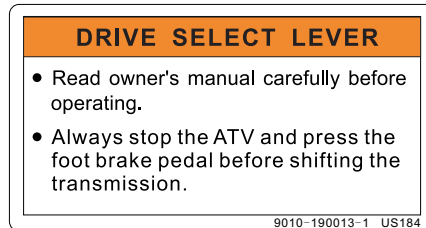
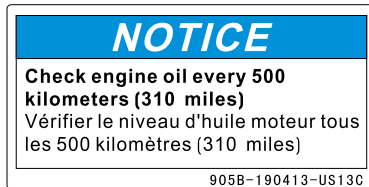

## Features and Controls

### Left Hand Controls

#### Override Button - 1

The engine is normally speed limited when operating in 4WD-LOCK. If conditions require more engine power in 4WD-LOCK:

- Release the throttle and press the button to override the speed limiting function. The override indicator light will come on.
- Reapply the throttle while this button is pressed. Releasing the button restores the speed limiting function.

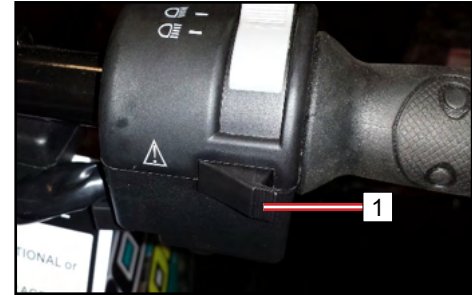

#### **⚠ WARNING**

Pressing the override button while the throttle is open in speed limiting mode may cause sudden acceleration, resulting in a loss of control, severe injury, or death. Always release the throttle before pressing the override button.

## FEATURES AND CONTROLS

### Headlight Switch - 2

The headlight switch consists of 4 positions:

: When the switch is at this position, Hi beam, tail light, and instrument light are on.

: When the switch is at this position, Lo beam, tail light, and instrument light are on.

**OFF** : When the switch is at this position, tail light is off, instrument light is on.

: When the switch is at this position, the tail light and instrument light are on. Headlights are off.

### CAUTION

Don't use the headlights with the engine turned off for more than 15 minutes. The battery may discharge to the point that the starter motor will not operate properly. If this should happen, remove the battery and recharge it.

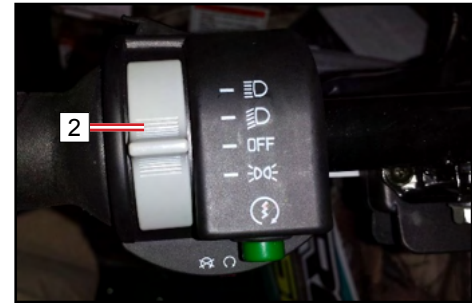





## FEATURES AND CONTROLS

### Horn Button - 3



Press the button "". The horn will sound.

### Engine Stop Switch - 4

: When the switch is moved to this position, the engine shuts off.

: When the switch is moved to this position, the engine can be started.

### Starter Switch - 5

When the main key switch is turned to ON, and the engine stop switch position is , push  button to start the engine.

### Turning light switch - 6 (select markets only)

When the switch is turned to left or right, left or right turning light is on.

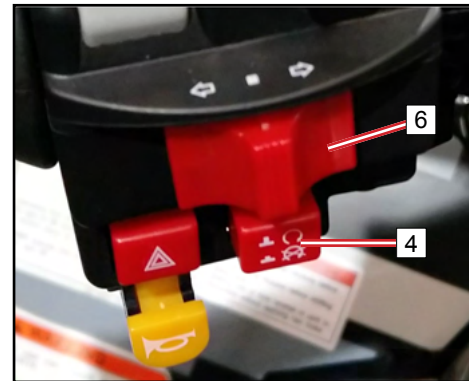
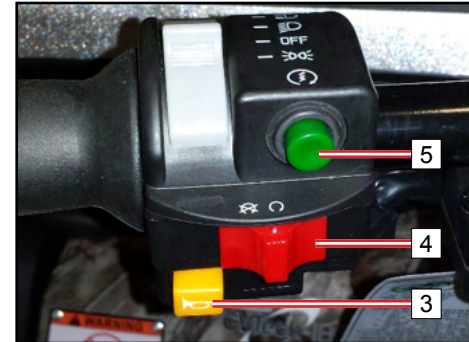

## FEATURES AND CONTROLS

### Right Hand Controls

#### Front Brake - 7

The front brake lever is located on the right handlebar and controls only the front brakes. Pull it toward the handlebar to apply the front brake. When squeezed, the lever should feel firm. Any sponginess would indicate a possible fluid leak or low master cylinder fluid level, which must be corrected before riding. Contact your dealer for proper diagnosis and repairs.

#### Front Brake Fluid Reservoir and Level Indicator - 8

Check the front brake master cylinder fluid level before each use of the ATV. The front brake master cylinder is located on the right handlebar. The fluid level can be viewed through the indicator window on the side of the master cylinder. If the fluid level is lower than the “lower” mark, refill with brake fluid as necessary.

#### **⚠️ WARNING**

An over-full master cylinder may cause brake drag or brake lock-up, which could result in serious injury or death. Maintain brake fluid at the recommended level. Do not overfill.

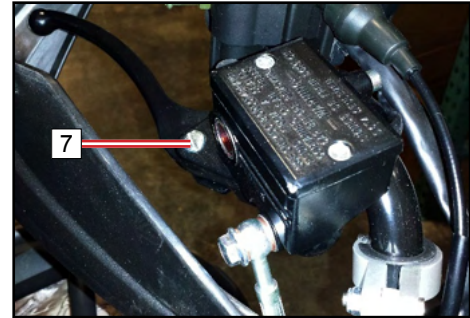

## FEATURES AND CONTROLS

### Throttle - 9

Before starting the engine, check the throttle to be sure it is operating smoothly. Make sure it returns to the idle position as soon as the lever is released.

Once the engine is running, movement of the throttle lever using your thumb will increase the engine speed. Regulate the speed of the vehicle by varying the throttle position. Because the throttle is spring loaded, the vehicle will decelerate and the engine will return to idle speed any time your thumb is removed from the throttle lever.

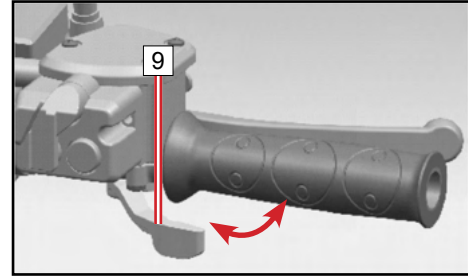

## FEATURES AND CONTROLS

### Mechanical Speed Limiter - 10

A mechanical speed limiter keeps the throttle from fully opening, even when the throttle lever is pushed to maximum travel. Turning in the screw limits the throttle lever travel, which reduces the maximum engine power available and decreases the maximum speed of the ATV.

### NOTE

Your ATV is set for maximum throttle opening from the factory.

### CAUTION

Always loosen the locking nut (a) before each adjustment. Do not turn the adjusting screw out more than 12 mm (0.47 in). Always make sure the throttle lever free play remains adjusted to 3mm~5mm (0.12 in~0.20 in). Tighten the locking nut when the adjustment is completed.

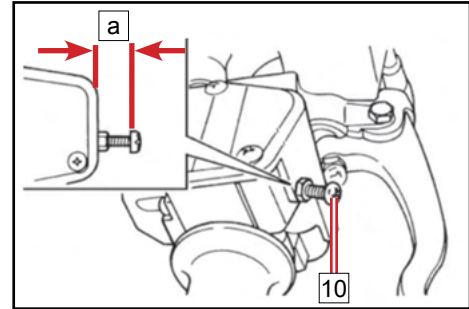

## FEATURES AND CONTROLS

### 2WD / 4WD Switch - 11

This ATV is equipped with an on-command “2WD”/”4WD” switch and a front diff-lock “LOCK”/”4WD” switch. Select the appropriate drive mode according to terrain and conditions:

- **Two-wheel drive (2WD):** Power is supplied to the rear wheels only.
- **Four-wheel drive (4WD):** Power is supplied to the rear wheels, and to the front wheels.
- **Four-wheel drive with diff-lock (4WD-LOCK):** Power is supplied to the rear and front wheels and the front differential is locked. Unlike 4WD mode, all the wheels turn at the same speed. Speed is limited to 22 mph (35 km/h).

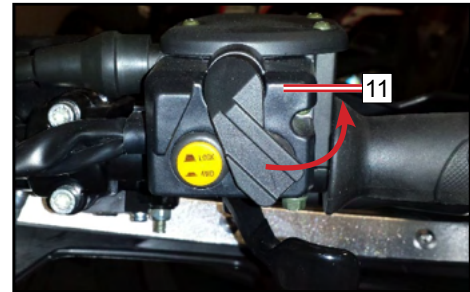
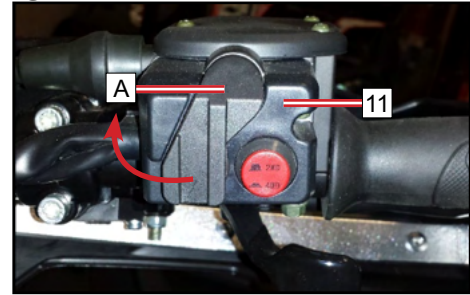

## FEATURES AND CONTROLS

### On-Command 2WD / 4WD Mode Switch Operation

**To change from 2WD to 4WD:** Stop the ATV. Verify the mode lever (A) is moved to the left, and then press the switch to “4WD”. The 4WD indicator “” will display in the dashboard.

**To change from 4WD to 2WD:** Stop the ATV. Verify the mode lever (A) is moved to the left, and then depress the switch to “2WD”. The 2WD indicator “” will display in the dashboard.

**To change to 4WD-LOCK:** Stop the ATV. To lock the front differential while in 4WD mode, verify the mode lever (A) is moved to the right, and then depress the switch (B) to “LOCK”. The 4WDLOCK indicator “” will display in the dashboard.

### NOTE – 4WD-LOCK OPERATION:

- Steering will require greater effort in 4WD-LOCK mode. This is normal.
- When the switch is set to “LOCK”, the front diff-lock indicator light will flash until the front diff is locked.
- If the indicator light is flashing, turning the handlebar left and right will help the front gear locking mechanism to engage.
- Riding before the front diff lock is properly engaged (e.g., the indicator light is flashing) will cause the engine speed to be limited until engagement is complete.
- When the ATV is in 4WD-LOCK, the maximum traveling speed is limited to 22 mph (35 km/h).
- If conditions require full engine power to be available, press the override switch on the front of the left-hand control to disable the 4WD-LOCK speed limiter.

## FEATURES AND CONTROLS

### Foot Controls

#### Foot Brake - 12

The foot brake pedal is located on the right side floor board of the vehicle. Push down on the pedal to apply both the front and rear brakes. When pressed, the pedal should feel firm. A soft brake pedal would indicate a possible fluid leak or low master cylinder fluid level, which must be corrected before riding. Contact your dealer for proper diagnosis and repairs.

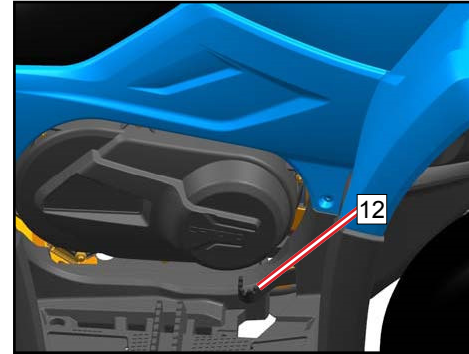

#### Foot Brake Fluid Reservoir and Level Indicator - 13

Check the foot brake master cylinder fluid level before each use of the ATV. The foot brake master cylinder is located under the front access cover. The fluid level can be viewed on the side of the master cylinder. If the fluid level is lower than the “lower” mark, refill with brake fluid as necessary. The foot brake fluid reservoir is near the right foot rest under the front access panel.

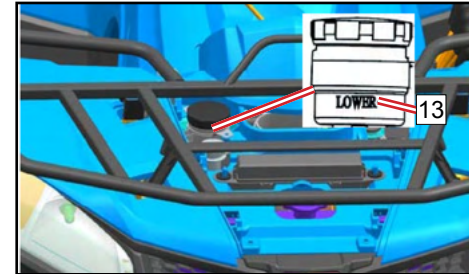

#### **⚠️ WARNING**

An over-full master cylinder may cause brake drag or brake lock-up, which could result in serious injury or death. Maintain brake fluid at the recommended level. Do not overfill.

## FEATURES AND CONTROLS

### **NOTE**

When checking the fluid levels, the ATV must be on level ground with the handlebars straight. If the fluid level is lower than the “lower” mark, add DOT4 brake fluid. Don't overfill.

### **WARNING**

Never store or use a partial bottle of brake fluid. Brake fluid is hygroscopic, meaning it rapidly absorbs moisture from the air. The moisture causes the drop of boiling temperature of the brake fluid, which can lead to early brake fade and the possibility of accident or severe injury. After opening a bottle of brake fluid, always discard any unused portion.



## FEATURES AND CONTROLS

### Parking - 14

To park the ATV, stop the engine, press the foot brake, and shift the gear selector lever into the parking position. Shake the vehicle forward and backward to verify that parking is engaged.



### ⚠ CAUTION

Always stop the ATV and press the foot brake pedal before shifting the transmission. Never depend on the parking feature alone if the ATV is parked on a hill. Always block the wheels on the downhill side of the ATV to prevent movement. It is recommended to park the ATV on level ground.

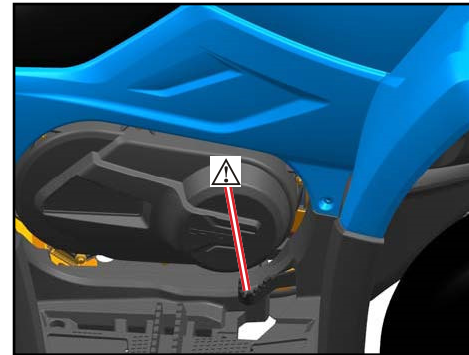

## FEATURES AND CONTROLS

### Vehicle Features

#### Main Key Switch - 15

The functions of the main key switch positions are as follows:

☉: All electrical circuits are switched on. The engine can be started at this position. The key cannot be removed in this position.

⊗: All electrical circuits are switched off. The key can be removed in this position

#### NOTE

Remove and store the spare key in a safe place. Your key can be duplicated only by mating a key blank with one of your existing keys. If both keys are lost, the complete switch assembly must be replaced.

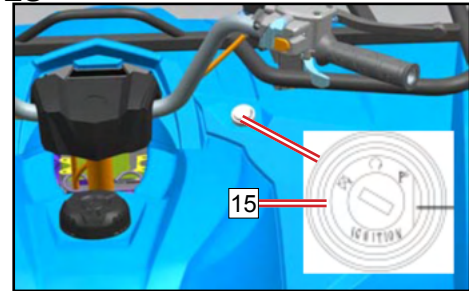

## FEATURES AND CONTROLS

### Fuel Tank - 16

The fuel tank fill cap is located at the top of the vehicle behind the handlebars. Cap removal is left-handed rotation. Cap installation is right-handed rotation.

### Fuel Minimum Octane Rating

The recommended fuel for your ATV is minimum 89 Octane unleaded (maximum 10% ethanol is allowed). Non-oxygenated (ethanol-free) fuel is recommended for best performance in all conditions.

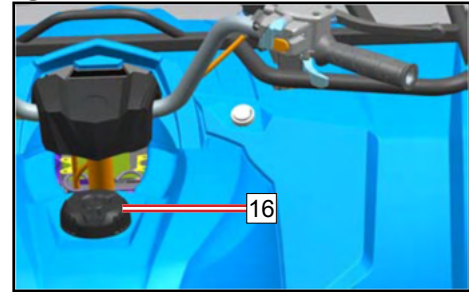

### Fuel Safety

#### **⚠️ WARNING**

- Allow the engine and exhaust system to cool before filling the tank.
- Gasoline is highly flammable and explosive under certain conditions.
- Always exercise extreme caution whenever handling gasoline.
- Always refuel with the engine stopped, and outdoors or in a well ventilated area.
- Never carry a plastic container with gasoline in the racks while riding. Static electricity between the rack and container could cause a spark.
- Do not smoke or allow open flames or sparks in or near the area where refueling is performed, or where gasoline is stored.
- Do not overfill the tank. Do not fill to the tank neck.

## FEATURES AND CONTROLS

- If gasoline spills on your skin or clothing, immediately wash it off with soap and water and change clothing.
- Never start the engine or let it run in an enclosed area. Engine exhaust fumes are poisonous and can cause loss of consciousness or death in a short time.
- The engine exhaust from this product contains chemicals known to cause cancer, birth defects or other reproductive harm. Operate this vehicle only outdoors or in well-ventilated areas.

### Transmission Gear Selector - 17

The transmission gear selector is located on the left side of the vehicle:

#### Gear Pattern

L – Low Gear  
H – High Gear  
R – Reverse Gear  
P – Park



Selector Direction

#### CAUTION

Always stop the ATV and press the foot brake pedal before shifting the transmission.

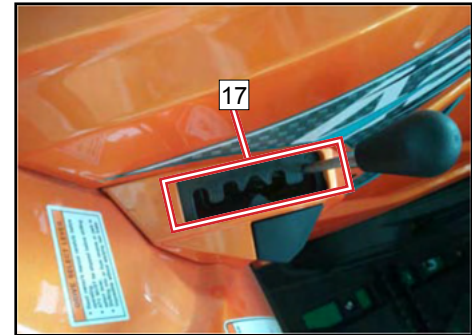

## FEATURES AND CONTROLS

### **12 Volt Accessory and USB Power**

Auxiliary 12Vdc and USB power outlets are provided on the left side front fender area for operating accessories such as hand held spot lights and charging electronic devices. Please consult with your dealer on the use of powered accessories with your vehicle.

### **Towing**

This vehicle is equipped with a receiver hitch, a trailer light receptacle at the left rear of the vehicle inner fender, and a trailer wiring adapter. Please consult with your dealer on towing and the use of trailers before using your vehicle.

### **Front panel access**

Your vehicle is equipped with an access panel in the front rack.

To remove the panel:

1. Lift the nose of the panel until you release the pin from the grommet.
2. Lift up lightly on the nose of the panel and press down in the center, then apply force toward the rear of the machine to release the six (6) L-shaped fasteners and remove.

To reinstall the panel:

1. Start at the rear of the cover and align the six (6) L-shaped fasteners.
2. Press down in the center of the cover and pull it toward you.
3. Guide and push the nose pin into the grommet to secure the panel.

# FEATURES AND CONTROLS

## Dashboard Features and Operation

### Indicators and Warnings

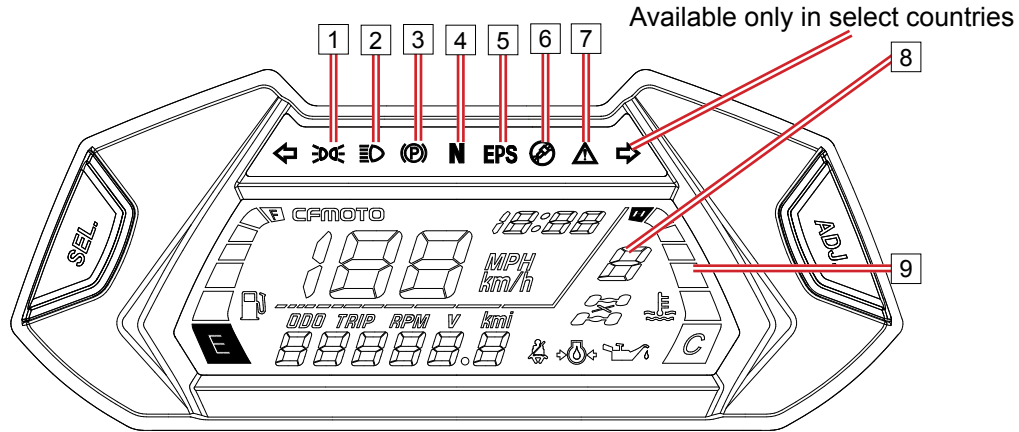

1	Tail Lamp ON	4	Gear selector in Neutral	7	Speed Limit Override
2	High Beam ON	5	EPS Fault (if equipped)	8	Gear Position R-H-L
3	Gear selector in Park	6	EFI Fault	9	Engine Temperature

## FEATURES AND CONTROLS

### Indicators and Warnings

- 1 - Tail Lamp ON. Illuminates when the headlight switch is in this position.
- 2 - High Beam ON. Illuminates when the headlight switch is in this position.
- 3 - Gear selector in Park. Illuminates when the gear selector is shifted to the parking position.
- 4 - Gear selector in Neutral illuminates when the gear selector is shifted to the NEUTRAL position.
- 5 - EPS Fault (This ATV is not equipped with EPS).
- 6 - EFI Fault. This indicator light comes on when a fault occurs in the Electronic Fuel Injection system.
- 7 - Speed Limit Override. This indicator light comes on when pressing the override switch on the left-hand control. Always exercise caution when using the override button.
- 8 - Gear Position 'R-H-L'. This dashboard section displays the following letters that correspond to gear selection: 'R'= Reverse; 'H'= High Gear; 'L'= Low Gear.
- 9 - Engine Temperature. This dashboard section displays the current coolant temperature, 'C' is low temperature, 'H' is high temperature, Both over-low and over-high are abnormal. Idle the vehicle to warm the engine when it's too cold, and park the vehicle when it's too hot to prevent the coolant from boiling. Keep the coolant temperature in a normal range.

# FEATURES AND CONTROLS

## Indicators and Warnings

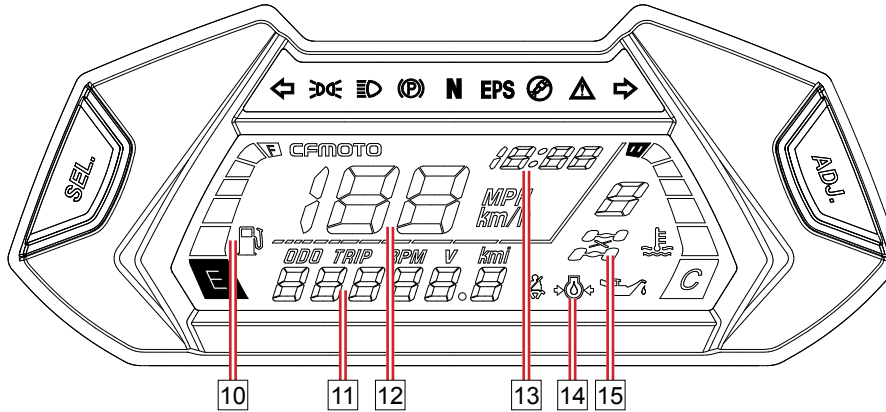

10	Fuel Gauge	12	Speedometer	14	Oil Pressure Warning
11	Odo / Trip / Rpm / H / V / Bright	13	Clock	15	4WD Indicator



## FEATURES AND CONTROLS

### Indicators and Warnings

- 10 - **Fuel Gauge.** This dashboard section displays the current gas remaining in the tank. 'F' indicates full. 'E' indicates stand-by fuel. When the indicator enters the red area, the fuel must be added as soon as possible.
- 11 - **Odometer / Trip / Rpm / Hour / Brightness Display.** This dashboard section can be toggled using the 'SEL' button to display; 'ODO' -The accumulated vehicle distance traveled, 'TRIP' - The trip distance traveled, 'RPM' – The engine speed in Revolutions Per Minute (RPM), 'V' - Voltage, 'H'-The engine hour meter records the engine running time, 'L-I-g-H—5' - Dashboard brightness (5 levels).
- 12 - **Speedometer.** This dashboard section can be toggled to display the vehicle speed in Kilometers per hour (Km/h) or Miles Per Hour (MPH).
- 13 - **Clock.** This dashboard section can be adjusted to the correct time using the 'ADJ' button.
- 14 - **Oil Pressure Warning.** This dashboard section displays when the engine oil pressure is abnormal, and is off when oil pressure is normal.
- 15 - **4WD Indicator.** This dashboard section corresponds to the drive method chosen on the right-hand control. The front differential contains the synchronizing component that signals the display.

## FEATURES AND CONTROLS

### Dashboard Navigation / Settings / Adjustments

Item	Display	SEL / ADJ Button	Result
Metric / Standard Toggle	Speed/Distance	Long Press 'SEL'	Metric ↔ Standard Values
Distance/RPM/Item Toggle	Vehicle Odometer Trip Distance Engine RPM Engine Hour Battery Voltage Brightness Setting	Short Press 'SEL'	ODO → TRIP → RPM → H → V → L-I-g-H--5 → ODO
Trip Distance Reset	Trip Distance	Long Press 'ADJ' in Odometer mode	Distance reset to zero
Clock - Hours Adjustment	Time	Short Press 'ADJ'	Incremental 1-12
Clock - Minutes Adjustment	Time	Long Press 'ADJ'	Incremental 00-59
Dashboard Brightness	L-I-g-H--5	Short Press 'ADJ'	5 levels of brightness

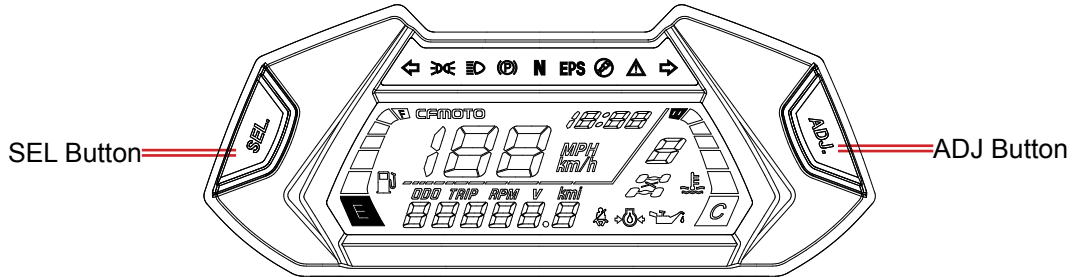

## Operation of Your ATV

### Break-In Period

The break-in period for your new ATV is very important. Careful treatment of a new engine at the beginning of ownership will result in more efficient performance and longer life. Perform the following procedures carefully:

1. Select an open area that allows room to familiarize yourself with vehicle operation and handling.
2. Place the ATV on a level surface.
3. Fill the fuel tank with gasoline.
4. Check the engine oil level. Add the recommended oil if necessary to maintain the oil level between the minimum and maximum indicators on the dipstick.
5. Position yourself in the operating position on the vehicle and start the engine. Allow the engine to idle for a short period before operating.
6. Press the foot brake, select the desired gear, and then release the foot brake.
7. Apply throttle. Drive slowly at first, varying throttle positions to  $\frac{1}{2}$  open for 10 hours, then vary to  $\frac{3}{4}$  open for another 10 hours. Do not operate at sustained idle or sustained wide open throttle.
8. Do not pull or carry any loads during the break-in period.
9. At the end of the break-in period, change the oil and filter (20hrs or 466 miles/750km).

## OPERATION OF YOUR ATV

### CAUTION

During the 20-hour break-in period:

- Do not load or tow cargo.
- Do not operate at sustained full throttle. Damage to engine parts or decrease engine life may result if excessive wide open throttle is used during the first 20 hours of use.
- Do not run engine with throttle over 1/2 open during the first 10 hours of use.
- Do not run engine with throttle over 3/4 open during the first 10 to 20 hours of use.
- Use of any oil other than those recommended may cause serious engine damage. CFMOTO recommends the use of SAE 5W-40/SG oil for single-cylinder 4-stroke engines. Changing engine oil viscosity due to extreme cold or hot environments is acceptable, as long as the oil used carries an API rating of 'SG' or better.

## OPERATION OF YOUR ATV

### Pre-Ride Inspection

Before each use of the vehicle, a best practice is to complete the pre-ride inspection checklist.

#### **⚠️ WARNING**

If a proper inspection is not done before each use, severe damage to the vehicle, severe injury, or death could result. Always inspect the vehicle before each use to ensure it is in proper operating condition.

Pre-Ride Checklist		
Item	Remarks	Page Reference
Air Filter	Inspect. Clean or replace as necessary	113
Air Box Sediment Tube	Drain deposits whenever visible	113
Brake System / Lever Travel	Ensure proper operation	53,58
Brake Fluid Reservoirs	Ensure proper level	53,58
Front Suspension	Inspect. Lubricate if necessary	139
Rear Suspension	Inspect. Lubricate if necessary	139
Steering	Ensure free operation	-
Tires	Inspect condition and pressure	141
Wheels / Fasteners	Inspect. Ensure fastener tightness	141
Frame Fasteners	Inspect. Ensure fastener tightness	-
Engine Fuel and Oil	Inspect for leaks. Ensure proper levels	109
Coolant Level	Ensure proper level	125
Coolant Hoses	Inspect for leaks	-

## OPERATION OF YOUR ATV

Pre-Ride Checklist		
Item	Remarks	Page Reference
Gear case Oil	Ensure proper level. Front and Rear	117
Gear Shifting	Ensure proper operation	-
Throttle Lever	Ensure proper operation	-
Headlights	Ensure proper operation	-
Brake Light / Tail Light	Ensure proper operation	-
Riding Gear	Wear helmet, gloves, protective clothing	43

### Starting the Engine

#### **WARNING**

Engine exhaust contains poisonous carbon monoxide and can cause loss of consciousness, resulting in severe injury or death. Never run an engine in an enclosed area.

#### Starting a cold engine

1. Verify the gear selector is shifted to the Parking or Neutral position.
2. Apply the foot brake.
3. Turn the engine stop switch and main key switch to “” (ON)
4. Verify the throttle is completely closed, then push the start switch on the left-hand control.
5. Once the engine starts, continue to warm the engine for a short period before operating the vehicle.

## OPERATION OF YOUR ATV

### **NOTE**

Do not activate the starting system more than 10 seconds on each attempt. If the engine fails to start, release the start switch, pause a few seconds before the next attempt, then push the start switch again. Each attempt should be as short as possible to preserve battery energy.

### **CAUTION**

Operating the vehicle immediately after starting could cause engine damage. Allow the engine to warm up for a short period before operating the vehicle.

### **NOTE**

The engine can be started in any gear if the brake is applied. However, a best practice is to shift into Neutral or Park before starting the engine. If the neutral indicator light on the dashboard does not come on when the gear selector is in neutral position, ask your dealer to inspect the vehicle electrical circuit or adjust the gear shifting system.

### **WARNING**

Excessive throttle operation while in speed limit mode may cause fuel to build in the exhaust, resulting in engine popping and/or engine damage.

## OPERATION OF YOUR ATV

### Gear Selector Operation

#### Shifting

#### CAUTION

To avoid transmission damage, return the throttle to the closed position, stop the vehicle, and apply the foot brake before shifting.

#### NOTE

Low gear is the preferred transmission gear selection for all forward motion other than prolonged high speed travel.

#### Shifting out of Park

1. Verify the throttle is closed.
2. Apply the foot brake.
3. Shift to the desired gear by moving the gear selector along the shift guide.

#### Shifting: Neutral to High Gear

1. Verify the throttle is closed and the vehicle is stopped completely.
2. Apply the foot brake.
3. Shift to 'H' by moving the gear selector along the shift guide.

#### Shifting: High Gear to Low Gear

1. Verify the throttle is closed and the vehicle is stopped completely.
2. Apply the foot brake.
3. Shift to 'L' by moving the gear selector along the shift guide.





## OPERATION OF YOUR ATV

### **Shifting: Low Gear to High Gear**

1. Verify the throttle is closed and the vehicle is stopped completely.
2. Apply the foot brake.
3. Shift to 'H' by moving the gear selector along the shift guide.

### **Shifting: to Reverse Gear**

1. Verify the throttle is closed and the vehicle is stopped completely.
2. Apply the foot brake.
3. Shift to 'R' by moving the gear selector along the shift guide.
4. Check behind you for people or obstacles, then release the rear brake pedal.
5. Apply the throttle lever gradually and continue to watch behind you while moving backward.

### **WARNING**

When you shift into reverse, make sure there are no obstacles or people, and the area is safe behind you. When it is safe to proceed, go slowly.

### **Shifting: Reverse to Park**

1. Verify the throttle is closed and the vehicle is stopped completely.
2. Apply the foot brake.
3. Shift to 'P' by moving the gear selector along the shift guide.

## **OPERATION OF YOUR ATV**

### **NOTE**

The gear selector must not be shifted into reverse gear without applying the foot brake.

The gear shift indicators should display corresponding to the actual gear position, if the indicator does not display, ask your dealer to inspect the vehicle electrical circuit or adjust the gear shifting system.

Due to the synchronizing mechanism in the engine, an indicator may not display until ATV starts moving.

Do not use high gear for continuous slow speed travel or towing, as this can lead to excessive heating of the clutch system, which may damage components.

## OPERATION OF YOUR ATV

### Hauling and Towing Cargo

Your vehicle is equipped with front and rear cargo racks, and a hitch receptacle for towing. Follow these guidelines for hauling and towing of cargo:

#### **WARNING**

Overloading the vehicle, carrying or towing cargo improperly, can alter the vehicle handling and may cause loss of control or braking instability.

- Always use low gear while towing to avoid clutch wear and belt issues.
- Reduce speed when hauling or towing loads.
- Never exceed the stated load capacity for this vehicle.
- All loads must be secured before operation. Unsecured loads may shift and create unstable operating conditions, which could result in loss of control of the vehicle.
- When operating over rough or hilly terrain, reduce speed and cargo to maintain stable driving conditions.
- Use extreme caution when applying brakes with a loaded vehicle. Avoid terrain or situations that may require backing downhill.
- Weight distribution on the front and rear racks should be as far forward and as low as possible. Carrying a high load raises the center of gravity and creates an unstable operating condition. Reduce load weight when the cargo center of gravity is high. When handling off-centered loads that cannot be centered, secure the load and operate with extra caution.

## **OPERATION OF YOUR ATV**

- When operating with loads extending beyond the rack. Stability and maneuverability may be adversely affected, causing the machine to overturn.
- Carrying a load on only the front rack or the rear rack may cause an imbalanced condition and increases the possibility of vehicle overturn. Balance loads proportionally between the front rack and the rear rack, but do not exceed the stated load capacity.
- Do not obstruct the headlights when loading the front rack.
- Always attach to the towable using the hitch point. Never exceed the recommended tongue weight.
- Using chains, straps, rope or other materials to tow objects is not recommended, as these items could get caught in the rear wheels, resulting in vehicle damage or personal injury.
- While towing, the vehicle should never exceed 10 mph (16 km/h) towing a load on a level surface. Vehicle speed should never exceed 5 mph (8 km/h) when towing loads in rough terrain, while cornering, or while ascending or descending a hill.

## OPERATION OF YOUR ATV

### Load Distribution

Your vehicle has been designed to carry or tow a certain amount of load. Always:

- Read and understand the load distribution warnings listed on the warning labels.
- Never exceed the specified weights.
- Cargo weight should be mounted as low as possible.
- Cargo should be loaded on the racks as far forward as possible.
- When operating over rough or hilly terrain with loads or towing, reduce speed and cargo to maintain stable driving conditions.

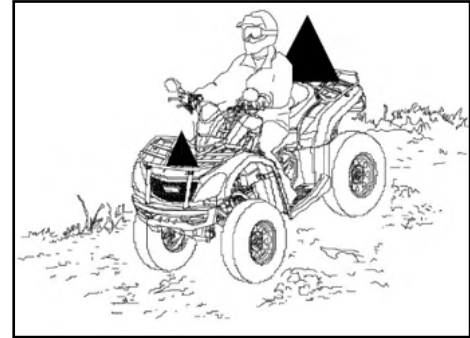

## **OPERATION OF YOUR ATV**

### **Driving Safely**

#### **Responsibilities of the operator**

As the operator of this ATV, your common sense, judgment, and abilities are the only factors that will prevent injury to yourself, to others around you, and/or damage to the vehicle or environment.

#### **Recreational, group, and distance riding**

One of the benefits of this vehicle is that it can take you off-road away from most communities. Stay away from areas designated for other types of off-road use unless it is specifically allowed. This includes snowmobile trails, equestrian trails, cross country ski trails, mountain bike trails, etc. Join a local ATV club. A club can provide you with a map and advice, or inform you about areas where you can ride.

Always keep a safe distance from other riders ahead of you and behind you when riding in a group. Never operate carelessly or make unexpected maneuvers with other ATVs close by. Stay on designated trails and riding areas, and discourage others from operating in unauthorized locations.

#### **Environment**

Off-road ATV recreation is a privilege. Maintain your privilege by respecting the environment and the rights of others to enjoy it. Chasing wildlife is illegal. Wildlife can die of exhaustion if chased by a motorized vehicle. Never purposely damage the terrain unless the operating area is designated for that type of activity. Observe the rule... "what you take in, carry out". Do not litter.

## **OPERATION OF YOUR ATV**

### **Practice!**

The driving procedures described in this manual should be practiced at slow speed many times in a large area with no obstacles. If an incorrect technique is used, your ATV may continue to go straight. If the ATV does not turn, come to a stop and then practice the procedure again. If the riding surface is slippery or loose, it may help to transfer more of your weight to the front wheels by moving forward on the seat. Once you have learned the proper techniques, you should be able to perform maneuvers at higher speeds or in tighter curves.

Improper driving procedures such as abrupt throttle changes, excessive braking, incorrect body movements, or too much speed for the sharpness of the turn may cause the ATV to tip. If the ATV begins to tip over to the outside while negotiating a turn, lean more to the inside. It may also be necessary to gradually let off on the throttle and steer to the outside of the turn to avoid tipping over.

Remember: Avoid higher speeds until you are thoroughly familiar with the operation of your ATV.

### **NOTE**

Low gear is the preferred transmission gear selection for all forward motion other than prolonged high speed travel. Do not use high gear for continuous slow speed travel or towing, as this can lead to excessive heating of the clutch system, which may damage components.

## OPERATION OF YOUR ATV

### Driving procedure

1. Sit upright with both feet on the footrests and both hands on the handlebars.
2. Start the engine and allow it to warm up. Apply the foot brake, then shift the transmission into low gear.
3. Check your surroundings and determine your path of travel.
4. Release the brakes.
5. Slowly press the throttle with your right thumb and begin driving. Vehicle speed is controlled by the amount of throttle opening.
6. Drive slowly. Practice maneuvering while using the throttle and brakes on a level surface.

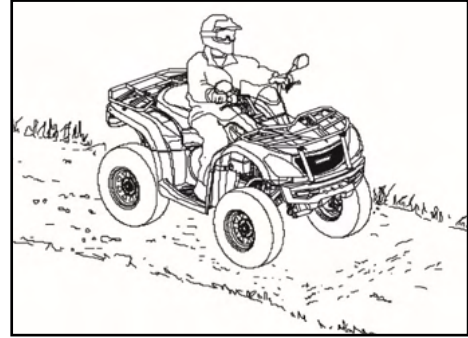



## OPERATION OF YOUR ATV

### Making turns

To make a turn, steer in the direction of the turn and lean your upper body to the inside of the turn, while supporting your weight on the outer footrest. This technique alters the balance of traction between the wheels, allowing the turn to be made smoothly. The same leaning technique should be used for turning in reverse.

### NOTE

Practice making turns at slow speeds before attempting to turn at faster speeds.

### ⚠️ WARNING

Turning at sharp angles or at excessive speeds can result in vehicle overturn and lead to serious injury. Avoid turning at sharp angles. Never make turns at high speeds.

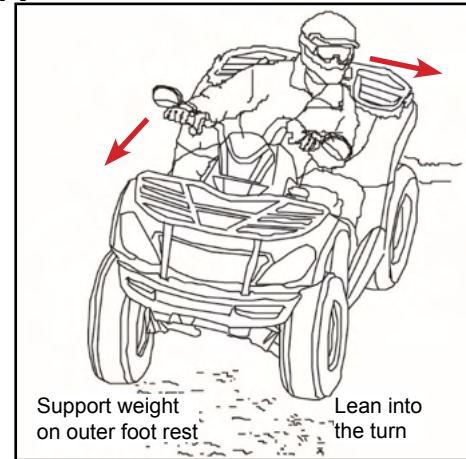

## **OPERATION OF YOUR ATV**

### **ATV turning dynamics**

To achieve maximum traction while operating in 2WD or 4WD, the two rear wheels perform as one axle and turn together at the same speed. Furthermore, when operating in 4WD-LOCK mode, the front wheels will also turn together at the same speed. Therefore, unless the wheel on the inside of the turn is allowed to slip or lose some traction, the ATV will resist turning. The special turning technique described in this manual must be used to allow the ATV to make turns quickly and easily. It is essential that this skill be learned first at low speed.

### **Turning on curves**

As you approach a curve, slow down and begin to turn the handlebars in the desired direction. As you do so, put your weight on the foot board to the outside of the turn (opposite the desired direction) and lean your upper body into the turn. Use the throttle to maintain an even speed through the turn. This maneuver will let the wheel on the inside of the turn slip slightly, allowing the ATV to maneuver the turn properly.

## OPERATION OF YOUR ATV

### Driving in reverse

#### To operate in reverse:

1. Ensure the throttle is closed and the vehicle is stopped completely.
2. Apply the foot brake, then shift the transmission into reverse gear.
3. Check for obstacles or people behind the vehicle.
4. When it's safe to proceed, release the brakes, slowly press the throttle with your right thumb, and back slowly. Vehicle speed is controlled by the amount of throttle opening.

### NOTE

Your ATV is equipped with a reverse speed limiter. The override button cannot be used. Do not operate at wide open throttle. Open the throttle just enough to maintain a desired speed.

Follow these precautions when operating in reverse:

- Always avoid backing downhill.
- Back slowly.
- When in reverse, apply the brakes lightly for stopping.
- Avoid turning at sharp angles in reverse.
- Never open the throttle suddenly while backing.

### **WARNING**

Failure to use caution when operating in reverse can result in serious injury or death.

## OPERATION OF YOUR ATV

### Driving on slippery surfaces

Whenever driving on slippery surfaces such as wet trails, loose gravel, sand, or during freezing weather, follow these precautions:

- Slow down when entering slippery areas.
- Maintain a high level of alertness, reading the trail in front of you as you drive. Avoid quick, sharp turns which can cause skids.
- Correct a skid by turning the handlebars in the direction of the skid and shifting your body weight forward.
- Driving with 4WD engaged can assist in controlling the vehicle in slippery areas.



### **⚠ CAUTION**

Severe damage to drive train may occur if 4WD is engaged while the wheels are spinning. Always engage 4WD when the wheels are at rest.

### **⚠ WARNING**

Failure to exercise care when operating on slippery surfaces can result in loss of tire traction and loss of control, an accident, and serious injury or death. Never apply the brakes during a skid. Do not operate on excessively slippery surfaces. Always reduce speed and use additional caution.

## OPERATION OF YOUR ATV

### Driving on rough terrain

Whenever driving on rough surfaces such as trails with large rocks or other obstacles, follow these precautions:

- Slow down when encountering rough terrain.
- Maintain a high level of alertness, reading the trail in front of you as you drive. Avoid quick, sharp turns which can cause a loss of control.
- Shift your body weight to counteract the weight of the vehicle if it tips to one side.
- Driving with 4WD or 4WD-LOCK engaged can assist in controlling the vehicle.



## OPERATION OF YOUR ATV

### Driving over obstacles

Be alert! Learn to look ahead and to read the terrain as you drive. Be constantly alert for hazards such as logs, rocks, and low hanging branches.

Never attempt to cross over an obstacle higher than the ground clearance of the vehicle.

### **WARNING**

Severe injury or death can result if your vehicle comes in contact with obstacles. Travel with caution on unfamiliar terrain.



## OPERATION OF YOUR ATV

### Driving through water

Your ATV can operate through water with a maximum recommended depth equal to the bottom of the footrests. Follow these procedures when operating through water:

- Determine water depths and current before crossing.
- Choose a crossing where both banks have gradual inclines.
- Proceed slowly, avoiding rocks and obstacles if possible.
- After crossing, dry the brakes by applying light pressure to the lever until braking action is normal.

### **⚠**WARNING

Avoid operating the vehicle through deep or fast-flowing water. If you cannot avoid water that exceeds the recommended maximum depth, go slowly, balance your weight carefully, avoid sudden movements, and maintain a slow and steady forward motion. Do not make sudden turns or stops, and do not make sudden throttle changes.

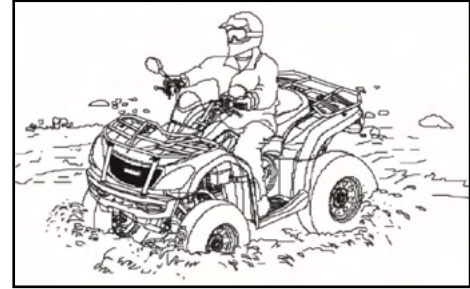

## **OPERATION OF YOUR ATV**

### **Drying the CVT system after submersion**

If water has been ingested into the CVT housing, the drive belt will likely slip and poor performance will result. To expel water and dry the CVT housing; Drain the CVT housing, place the vehicle in neutral, and raise the engine rpm for several minutes to dry the CVT components. Release the throttle and shift into low gear, then test the performance of the vehicle. Repeat as necessary until you are satisfied all the water has been expelled. Contact your dealer if vehicle performance issues continue.

### **NOTE**

After running the vehicle in water, it is critical to have the vehicle serviced as outlined in the maintenance schedule. The following areas need special attention: engine oil, front and rear gear cases and all grease locations. If your vehicle becomes immersed, and it's impossible to take it to your dealer before starting it, follow the steps described in this manual to remove water from the air box and engine.

### **CAUTION**

Major engine damage can result if the vehicle is not thoroughly inspected after operation in water. If water has been ingested into the CVT housing, follow the procedure in this manual for drying out the CVT clutch system. Have the vehicle serviced by your dealer promptly if your vehicle becomes immersed or stalls in water that exceeds the footrest level. It is important to contact your dealer for service before starting the engine, as water may have been ingested in the air box and engine.



## OPERATION OF YOUR ATV

### Driving on hills

#### Driving uphill

Whenever traveling uphill, follow these precautions:

- Never operate on hills over 22° degrees incline or hills too steep for your abilities.
- Always travel straight uphill.
- Keep both feet on the footrests.
- Shift your weight forward.
- Maintain a steady rate of speed and throttle opening.
- Remain alert and be prepared to take emergency action. This may include quick dismounting of the vehicle.

#### If all forward uphill speed is lost:

Keep your weight uphill and release the throttle.

Apply the front brake. When fully stopped, apply the foot brake and shift the gear selector to the parking position.

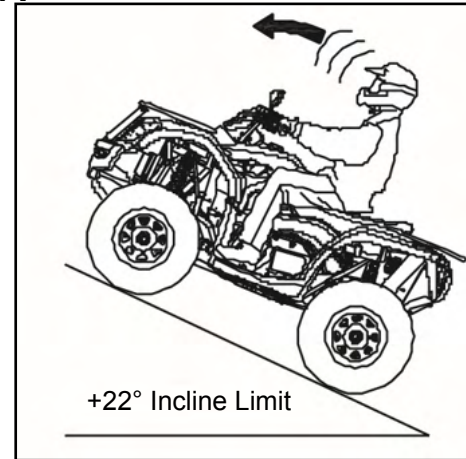

## OPERATION OF YOUR ATV

### **If the ATV begins rolling backwards:**

Keep your weight uphill. Never apply engine power. Never apply the foot brake while rolling backwards.

Apply the front brake. When fully stopped, apply the foot brake and shift the gear selector into the parking position.

Dismount on uphill side, or to either side if the ATV is pointed straight uphill. Turn the ATV around and remount following the procedure described in this manual.

### **WARNING**

Braking and handling are greatly affected when operating in hilly terrain. Improper hill climbing procedures could cause loss of control or overturn and result in serious injury or death. Avoid climbing steep hills. If the vehicle stalls, never back it down the hill. Use extreme caution when operating on hills, and follow the proper operating procedures outlined in the owner's manual.

## OPERATION OF YOUR ATV

### Sidehilling

#### **⚠️ WARNING**

Improperly crossing hills or turning on hills can result in loss of control or vehicle overturn, resulting in severe injury or death. Avoid crossing the side of a hill when possible. Follow the proper procedures as outlined in the owner's manual.

Sidehilling can be a dangerous type of driving and should be avoided if at all possible. If you do enter into a situation where sidehilling is necessary, follow these precautions:

- Slow down.
- Lean into the hill, transferring your upper body weight toward the hill while keeping your feet on the footrests.
- Steer slightly into the hill to maintain vehicle direction.

#### **⚠️ CAUTION**

If the vehicle begins to tip, quickly turn the front wheels downhill if possible, or dismount on the uphill side immediately.

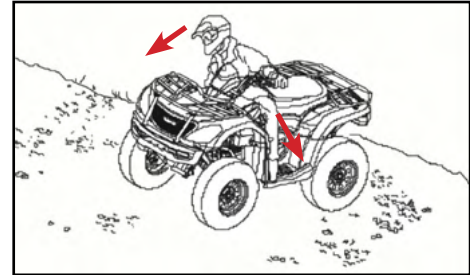

## OPERATION OF YOUR ATV

### Driving downhill

When traveling down a hill, follow these precautions:

- Never operate on hills over 22 degrees incline or hills too steep for your abilities.
- Slow down.
- Shift your weight to the rear of the vehicle.
- Always travel directly downhill.
- Utilize the engine braking function and apply the foot brake lightly to aid in slowing. Familiarize yourself with operation of these braking functions during downhill descents.
- Driving with 4WD or 4WD-LOCK engaged can assist in controlling the vehicle.

### **⚠**WARNING

Excessive downhill speed can cause loss of control and lead to serious injury or death. Always reduce speed when traveling downhill.

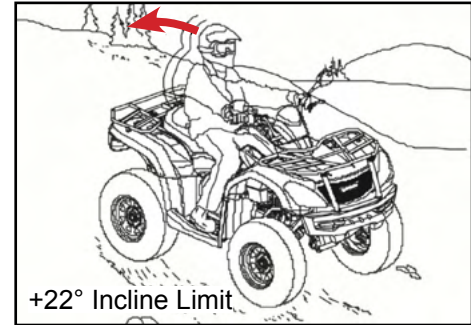

## OPERATION OF YOUR ATV

### Turning around on a hill

One maneuver that can be used when it's necessary to turn around while climbing a hill is a 'K-turn':

1. Release the throttle, then apply the hand and foot brake while keeping your body weight uphill.
2. Shift the gear selector lever to the low gear position. Shut off the engine.
3. Keeping the hand brake applied, dismount on the uphill side of the vehicle, or on the right side if the vehicle is pointing straight uphill.
4. Keeping the hand brake applied and staying uphill of the vehicle, turn the handlebars full left (front brake will be closest to you).
5. Slowly releasing the hand brake lever, allow the vehicle to roll around to the right until it's pointing across the hill or slightly downward.
6. Keeping the hand brake applied, remount the vehicle from the uphill side and shift the gear selector lever to the parking position, keeping your body weight uphill.
7. Restart the engine. Press the foot brake, and shift the gear selector lever to low gear position.
8. Release the brakes and proceed slowly downhill, controlling speed with the brakes, until the vehicle is on more level ground.

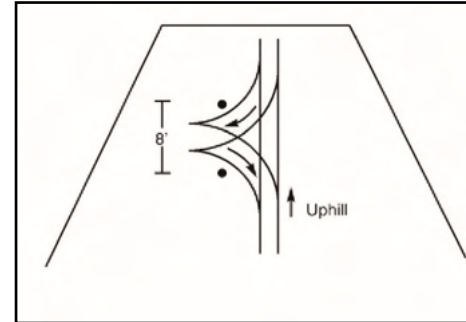

## OPERATION OF YOUR ATV

### Parking on an incline

Avoid parking on an incline if possible. If it's unavoidable, follow these precautions:

- Turn the engine off.
- Place the gear selector to parking position.
- Always block the rear wheels on the downhill side. Refer to the illustration.

### CAUTION

The rear output shaft is locked when the transmission is in the parking position.

### Crossing paved surfaces

Your ATV is not designed for paved surfaces and is more likely to tip over. Do not travel on sidewalks or bicycle lanes, as they are not designated for ATV use. If you must drive on a paved surface, reduce speed and avoid sudden turns, acceleration, or braking. If you have to cross a paved road, ensure you have complete visibility in both directions for oncoming traffic, and determine your exit point on the other side. Drive in a straight line toward that point. Do not make sharp direction changes or abrupt accelerations, as it may result in a tip over situation.

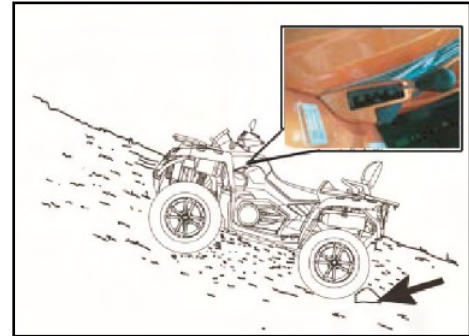

## Maintenance

Careful periodic maintenance will help keep your vehicle in the safest, most reliable condition. Inspection, adjustment, and lubrication of important components are explained in the periodic maintenance schedule.

Inspect, clean, lubricate, adjust, and replace parts as necessary. When inspection reveals the need for replacement parts, please use genuine parts available from your dealer.

### NOTE

Periodic service and adjustments are critical. If you are not familiar with performing safe service and adjustment procedures, have a qualified dealer perform the required maintenance for you.

### Severe Use Definition

CFMOTO defines severe vehicle use as:

- Frequent immersion in mud, water or sand
- Racing or race-style high RPM use
- Prolonged low speed, heavy load operation
- Extended engine idle
- Short trip, cold weather operation
- Vehicles used in commercial operations

For a vehicle that is subjected to severe use, decrease all maintenance and service intervals by 50%.

## MAINTENANCE

### NOTE

Pay special attention to the engine oil level during cold weather operation. A rise in engine oil level can indicate contaminants collecting in the oil sump or crankcase. Change oil immediately if the oil level begins to rise. Monitor the oil level, and if it continues to rise, discontinue use and determine the cause, or see your dealer.

### Periodic Maintenance Schedule and Icon Key

Maintenance intervals in the following schedule are based upon average riding conditions and an average vehicle speed of approximately 12.4 mph (20 km/h). Vehicles subjected to severe or commercial use must be inspected and serviced more frequently. The following icon keys are used to note special circumstances:

- ▶ = Perform the procedure more often on vehicles subjected to severe use.
- = Have an authorized dealer perform repairs that involve this component or system.
- ◆ = Emissions related components. Have an authorized dealer perform repairs that involve this component or system

### WARNING

Improperly performing the procedures marked as '■' could result in component failure and lead to serious injury or death. Have an authorized dealer perform these services.



# MAINTENANCE

## General recommended lubrication

Check all components at the intervals outlined in the Periodic Maintenance Schedule. Items not listed in the schedule should be lubricated at the general lubrication interval.

### KEY POINTS OF LUBRICATION SCHEDULE:

- Change Lubricants more often under severe use, such as wet or dusty conditions.
- Use All Season Grease on pivot points.
- Lubricate every 500km (310 miles), before long periods of storage, after pressure washing, or after submerging drivetrain.

Item	Lubricant	Method
Engine oil	SAE 5W-40/SG	Fully insert and remove dipstick to check oil level
Brake fluid	DOT4	Keep level between upper and lower lines
Front gear case oil	SAE80W/90 GL-5	Keep level at the filler rim
Rear gear case oil	SAE80W/90 GL-5	Keep level at the filler rim
Front/Rear Suspension Pivots	All Season Grease	Grease gun - Pump grease until it flows lightly from the pivot point

## MAINTENANCE

### Maintenance schedule

Item		► = Perform the procedure more often on vehicles subjected to severe use. ■ = Have an authorized dealer perform repairs that involve this component or system. ♦ = Emissions related components. Have an authorized dealer perform repairs that involve this component or system <b>Calendar-based Maintenance Interval (service whichever interval comes first)</b>		
		CALENDAR	km(Miles)	Remarks
■	Steering	Pre-Ride		Make adjustments as needed
►	Front suspension / CV	Pre-Ride		
►	Rear suspension / CV	Pre-Ride		
►	Tires	Pre-Ride		
►	Brake fluid levels	Pre-Ride		
►	Brake lever/Pedal	Pre-Ride		
►	Brake system function	Pre-Ride		
►	Wheels / Fasteners	Pre-Ride		
►	Frame fasteners	Pre-Ride		
►	Engine oil level	Pre-Ride		
►	Air box sediment tube	Daily		Drain and clean housing if deposits are visible

## MAINTENANCE

Item		<p>▶ = Perform the procedure more often on vehicles subjected to severe use.                      ■ = Have an authorized dealer perform repairs that involve this component or system.                      ♦ = Emissions related components. Have an authorized dealer perform repairs that involve this component or system  <b>Calendar-based Maintenance Interval (service whichever interval comes first)</b></p>		
		CALENDAR	km (Miles)	Remarks
	CVT inlet / outlet pipe and sediment tube	Daily		Drain and clean housing if deposits are visible; Check often if operating in wet conditions
▶	Air inlet / Air filter		322 (200)	Inspect and replace filter more often under severe use conditions
	Coolant	Daily	1500 (932)	Inspect reservoir level daily; Initial check at 250km; Change coolant every 2 years/ 6000km
	Head light / Tail light	Daily		Check operation
	Engine oil and filter change (Break-in)		250 (155)	Break-in change: 750km
■♦	Engine valve clearance		250 (155)	Adjust intake and exhaust valve clearance after break-in period
	Brake pad wear	Daily	100 (62)	Inspect
	Battery	Daily	200 (124)	Check terminals; clean; test

## MAINTENANCE

Item		► = Perform the procedure more often on vehicles subjected to severe use. ■ = Have an authorized dealer perform repairs that involve this component or system. ♦ = Emissions related components. Have an authorized dealer perform repairs that involve this component or system <b>Calendar-based Maintenance Interval (service whichever interval comes first)</b>		
		CALENDAR	km (Miles)	Remarks
►	Front gear case oil	Monthly	250 (155)	Inspect level; Change yearly
►	Rear gear case oil	Monthly	250 (155)	Inspect level; Change yearly
►	Engine oil	Monthly	250 (155)	Inspect level; Change yearly
	Gearshift	Monthly	500 (310)	Inspect; Lubricate; Adjust
►	General lubrication	3M	500 (310)	Lubricate all fittings, pivots, cables, etc.
■	Steering knuckle	6M	500 (310)	Inspect
■	Steering handlebar	6M	500 (310)	Inspect
►	Front suspension	6M	500 (310)	Lubricate
►	Rear suspension	6M	500 (310)	Lubricate
■	Throttle cable	6M	500 (310)	Inspect; Adjust; Lubricate; Replace if necessary

## MAINTENANCE

Item		<p>▶ = Perform the procedure more often on vehicles subjected to severe use.                      ■ = Have an authorized dealer perform repairs that involve this component or system.                      ♦ = Emissions related components. Have an authorized dealer perform repairs that involve this component or system  <b>Calendar-based Maintenance Interval (service whichever interval comes first)</b></p>		
		CALENDAR	km (Miles)	Remarks
♦	Air filter element		1500 (932)	Replace every 1500km depending on condition Initial inspection; 750km; Do not clean main filter element.
■	CVT drive belt		1500 (932)	Inspect; Replace if necessary. Replace every 3000km or 1 year
■	Cooling system		1500 (932)	Inspect coolant strength seasonally; Pressure test system yearly; Replace every 6000km or 2 years
▶	Engine / Transmission oil Change – normal service	12M	3000 (1864)	Perform break-in oil change at 750km
▶♦	Fuel hoses	12M	1000 (621)	Inspect routing, condition
■♦	Engine valve clearance	12M	3000 (1864)	Inspect ; Adjust as necessary Initial: 20h or 750km
■♦	Fuel system	12M	1000 (621)	Inspect fill cap, fuel pump, and fuel pump relay

## MAINTENANCE

Item		► = Perform the procedure more often on vehicles subjected to severe use. ■ = Have an authorized dealer perform repairs that involve this component or system. ♦ = Emissions related components. Have an authorized dealer perform repairs that involve this component or system <b>Calendar-based Maintenance Interval (service whichever interval comes first)</b>		
		CALENDAR	km (Miles)	Remarks
►	Oil and filter change	12M	3000 (1864)	Change oil more often in severe use conditions
►	Cooling hoses	12M	1000 (621)	Inspect ; Initial: 300km
►	Engine mounts	12M	3000 (1864)	Inspect. Initial: 300km
	Exhaust pipe and muffler	12M	1000 (621)	Inspect; Clean spark arrestor
	Ignition coil	12M	1000 (621)	Inspect connections
	ECU	12M	1000 (621)	Inspect connections
	Wiring and cables	12M	1000 (621)	Inspect for wear, routing, security; check internally if subjected to water, mud, etc.
■	Clutches(primary and secondary pulleys)	12M	3000 (1864)	Inspect; clean; replace worn parts
	Wheel bearings	12M	1600 (994)	Inspect and replace as necessary

## MAINTENANCE

Item		► = Perform the procedure more often on vehicles subjected to severe use. ■ = Have an authorized dealer perform repairs that involve this component or system. ♦ = Emissions related components. Have an authorized dealer perform repairs that involve this component or system <b>Calendar-based Maintenance Interval (service whichever interval comes first)</b>		
		CALENDAR	km (Miles)	Remarks
♦	Spark plug	12M	3000 (1864)	Initial inspection:750 km or 20hr Replace every 6000km
■	Brake fluid	24M	2000 (1242)	Change fluid
►	Radiator	24M	3000 (1864)	Change fluid; clean external surfaces regularly
	Engine Idle condition			Inspect =1500rpm±150rpm
■	Steering toe adjustment			Inspect periodically; Adjust when parts are replaced
■	Foot brake			Inspect daily; Adjust as necessary
	Headlight aim			Adjust as necessary

# MAINTENANCE

## Inspection and Service Record

INSPECTION AND SERVICE RECORD	SERVICE MUST BE CARRIED OUT ACCORDING TO THE MAINTENANCE SCHEDULE					
Inspection Number	1	2	3	4	5	6
Date						
km / Miles						
<p><b>Dealer Stamp and/or Signature</b></p>						



**MAINTENANCE**

<b>INSPECTION AND SERVICE RECORD</b>	<b>SERVICE MUST BE CARRIED OUT ACCORDING TO THE MAINTENANCE SCHEDULE</b>					
<b>Inspection Number</b>	<b>7</b>	<b>8</b>	<b>9</b>	<b>10</b>	<b>11</b>	<b>12</b>
<b>Date</b>						
<b>km / Miles</b>						
<b>Dealer Stamp and/or Signature</b>						

## MAINTENANCE

### Maintenance Procedures

#### Engine oil check

Always check and change the engine oil at the intervals outlined in the Maintenance Schedule.

1. Place the ATV on a level surface.
2. Start the engine and let it idle for (20~30) seconds. Stop the engine.
3. Wait a short period for the oil to settle.
4. Remove access cover **1** by grasping the lower right portion and pulling firmly.
5. Unscrew the oil dipstick **2** out and wipe off with a clean cloth.
6. Insert the dipstick into the oil filler hole. Do not reinstall it.
7. Remove the dipstick again and check the oil level indication. Maintain the oil level between the upper and lower indicators.
8. Reinstall the dipstick into the oil filler hole, hand-tighten it, and reinstall the access cover.

#### NOTE

Access cover grommets may come loose. Ensure they are in place before reinstalling the cover.

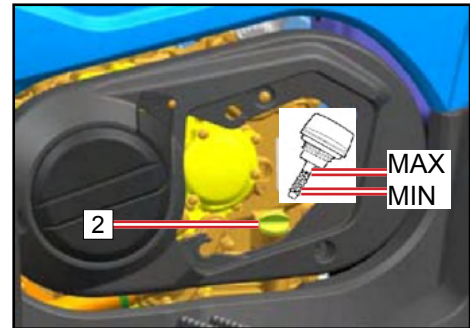

## MAINTENANCE

### Engine oil and filter change

1. Place the ATV on a level surface.
2. If the engine was running, wait a sufficient period for the oil to settle and cool.

### Crankcase drain and sump filter service

3. Place an oil pan under the engine to collect the used oil.
4. Remove the engine oil drain bolt **1** and drain the oil from the crankcase.
5. Remove the crankcase sump cover fasteners **2** and filter cover **3**.
6. Remove the crankcase sump filter, wash it in solvent, dry it, and reinstall with the cover and fasteners. Tighten the fasteners to 7.3 ft-lb. (10 N•m).
7. Place a new sealing washer on the engine oil drain bolt, then assemble and tighten the drain bolt to 22 ft-lb. (30 N•m).

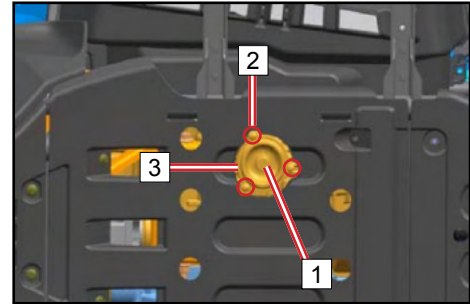

## MAINTENANCE

### Oil filter cartridge replacement

8. If necessary, remove the left cover panel to access the oil filter location. Remove the oil filter cover fasteners **4** and cover **5** from the crankcase.
9. Remove the oil filter cartridge **6** from the crankcase housing.
10. Install a new oil filter cartridge in the crankcase housing.
11. Inspect and verify the cover O-ring **7** is okay to reuse, and then install it into the groove of the crankcase housing correctly.
12. Install the oil filter cover and fasteners. Tighten the fasteners to 7.3 ft-lb. (10 N•m).
13. Add the specified amount of recommended engine oil, and then reinstall the engine oil dipstick and hand-tighten it.

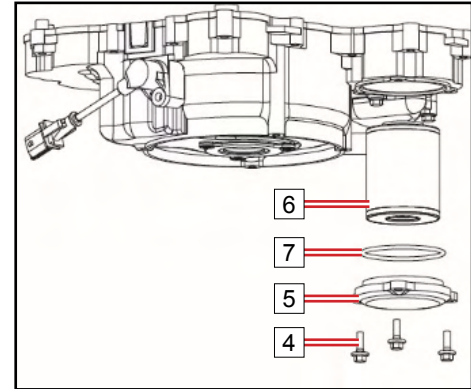

### NOTE

Without oil filter cartridge replacement: 2.4 qt. (2.27 L)

With oil filter cartridge replacement: 3.0 qt. (2.83 L)

14. Start the engine and allow it to warm up for several minutes. While warming up, check for oil leaks. If an oil leak is found, turn the engine off immediately and check for the cause.
15. Turn the engine off. Recheck the oil level and correct it if necessary.

## MAINTENANCE

### Engine valve train adjustment

The intake and exhaust valve clearances change with use of the vehicle, which can result in improper fuel/air supply or engine noise. To prevent this, the valve clearances must be adjusted according to the maintenance schedule. This adjustment should be performed by a professional service technician. Contact your dealer for service.

### NOTE

Engine intake valve clearance (cold engine): 0.003 in ~ 0.005 in. (0.08mm ~ 0.12mm)

Engine exhaust valve clearance (cold engine): 0.005 in ~0.007 in. (0.12mm ~ 0.18mm)

### Engine Idle Speed

This vehicle is equipped with an electronic fuel injection system. There are no provisions to adjust engine idle speed. The throttle body is a vital part of the fuel system which requires very sophisticated adjustment, and was set at the factory. If the settings are disturbed, poor engine performance and damage may result. Check engine idle speed for stability and contact your dealer for service if necessary. Contact your dealer in case of an abnormal engine idle condition.

### NOTE

Engine idle speed: 1500 rpm  $\pm$ 150 rpm (engine at operating temperature)

## MAINTENANCE

### Air filter

Always check and change the engine oil at the intervals outlined in the Maintenance Schedule. The air filter element should be cleaned more often if the machine is operated in extremely dusty or wet areas. Each time air filter maintenance is performed, check the air inlet of the air filter box for obstructions. Check the air filter housing rubber joint to the throttle body and manifold fittings for an airtight seal. Check that all fittings are secure to avoid the possibility of unfiltered air entering the engine.

### Air filter housing inspection

There is a check hose [1] at the bottom of the air filter housing. If dust or water can be viewed in this hose, empty the hose and clean the air filter housing thoroughly. If the vehicle was submerged, please contact your local dealer to check for water inside the engine crankcase.

### Air filter maintenance

1. Remove the seat.
2. Remove the cover spring clips [2], the cover screws [3], and then remove the filter housing cover.

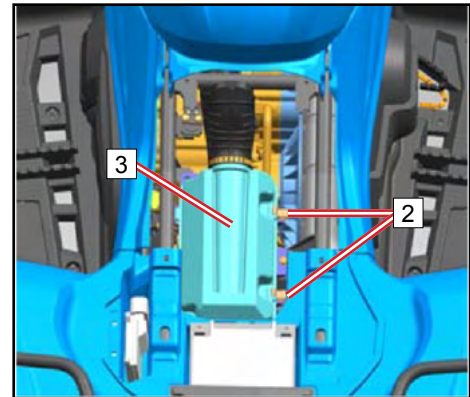
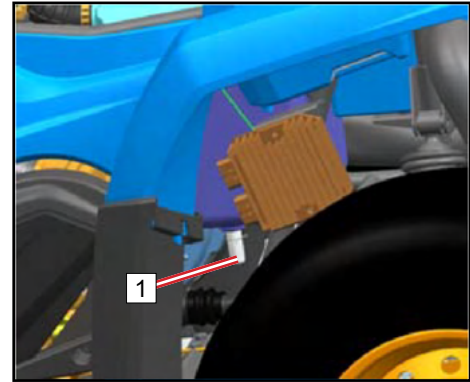

## MAINTENANCE

3. Loosen the air filter clamp [4] and remove the air filter [5].
4. Remove the foam pre-filter [6] from the air filter.
5. Wash the foam pre-filter gently with soap and water, and allow it to completely dry.
6. Inspect the paper air filter and verify it is okay to reinstall. Softly brush off accumulated dust if necessary. Install a new filter as necessary.

### NOTE

Do not wash paper air filters, or use compressed air to clean the filter media.

7. Install the pre-filter onto the air filter. Apply a thin film of lubricant on the inside diameter of the air filter rubber seal.
8. Install the air filter and clamp onto the air filter housing inlet. Tighten the clamp securely.
9. Reinstall the air filter housing cover and spring clips. Verify the cover is installed correctly and is sealing properly.

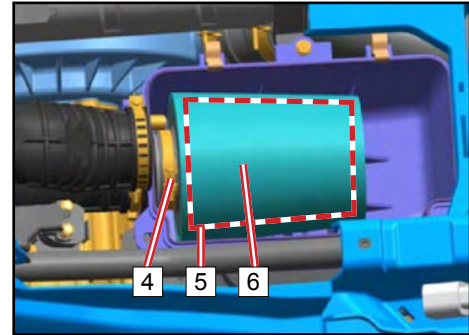

## MAINTENANCE

### **Drying the air filter housing after submersion**

If water has been ingested into the air filter housing, Drain the air filter housing, remove the air filter, and thoroughly dry the components. Do not use compressed air. Contact your dealer if vehicle performance issues exist.

### **CAUTION**

Do not operate the engine without an air filter element. Unfiltered air will enter into the engine and cause engine wear and damage. Driving without an air filter will also decrease performance and can lead to engine overheating.

### **CAUTION**

Major engine damage can result if the vehicle if water has been ingested into the air filter housing, and engine. Have the vehicle serviced by your dealer promptly if your vehicle becomes immersed or stalls in water that exceeds the footrest level. It is important to contact your dealer for service before starting the engine, as water may have been ingested in the air box and engine.



## MAINTENANCE

### Battery

This vehicle is equipped with a 12 volt / 30 Amp hour, sealed low-maintenance battery, which is located under the seat. Therefore, it is not necessary to check the electrolyte or add distilled water to the battery. If the battery seems to have discharged, consult your dealer. Verify that the battery connections are clean and secured during routine maintenance.

### Battery maintenance guidelines:

- If the vehicle will not be used for a month or longer, remove the battery and store it in a cool, dry place. Completely recharge the battery before reinstallation.
- A special battery charger (constant low voltage/ampere) is required for recharging lowmaintenance batteries. Using a conventional battery charger may shorten the battery life.
- Always make sure the cable connections are the correct polarity when reinstalling the battery. RED ('+' positive) / Black ('-' negative). Always disconnect the RED ('+' positive) cable last during removal, and reconnect it first during installation.
- Corroded battery connections can be cleaned with a mixture of baking soda and water.

### WARNING

Avoid contact with skin, eyes or clothing, and always shield eyes when working near batteries. Keep out of reach of children. Keep batteries away from sparks, flames, cigarettes or other sources of ignition. Ventilate the area when charging or using in a closed space.

## MAINTENANCE

### Battery acid antidote:

EXTERNAL: Flush with water.

INTERNAL: Get prompt medical attention.

EYES: Flush with water for 15 minutes and get prompt medical attention.

### Front and rear gear cases

The front and rear gear case must be checked for oil leaks before operating. If any leaks are found, have your dealer check and repair the vehicle.

### Front gear case oil measurement

1. Place the vehicle on a level surface.
2. Remove the oil filler bolt **1** and check the oil level. The level should be up to the brim of the hole. If the level is low, add sufficient oil to raise it to the specified level.
3. Install the oil filler bolt and tighten it to 17 ft-lb. (23 N•m).



## MAINTENANCE

### Front gear case oil change

1. Place the vehicle on a level surface.
2. Place an oil pan under the gear case to collect the used oil.
3. Remove the oil drain bolt **2** at the bottom of the gear case and drain the oil.
4. Install the oil drain bolt and tighten it to 17 ft-lb. (23 N•m).
5. Remove the oil filler bolt. Add sufficient oil to raise the level up to the brim of the hole.
6. Install the oil filler bolt and tighten it to 17 ft-lb. (23 N•m).

### NOTE

Approximate front gear case oil capacity: 6.7 oz. (198 mL)

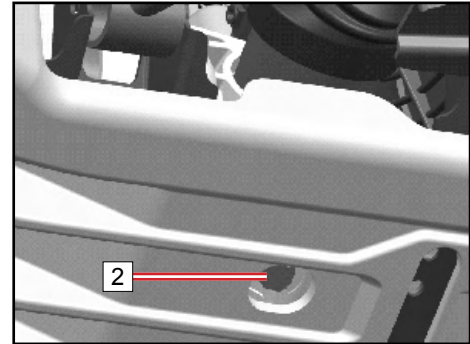

## MAINTENANCE

### Rear gear case oil measurement

1. Place the vehicle on a level surface.
2. Remove the oil filler bolt [3] and check the oil level. The level should be up to the brim of the hole. If the level is low, add sufficient oil to raise it to the specified level.
3. Install the oil filler bolt and tighten it to 17 ft-lb. (23 N•m).

### Rear gear case oil change

1. Place the vehicle on a level surface.
2. Place an oil pan under the gear case to collect the used oil
3. Remove the oil drain bolt [4] at the bottom of the gear case and drain the oil.
4. Install the oil drain bolt and tighten it to 17 ft-lb. (23 N•m).
5. Add sufficient oil to raise the level up to the brim of the hole.
6. Install the oil filler bolt and tighten it to 17 ft-lb. (23 N•m).

### NOTE

Approximate rear gear case oil capacity: 8.4 oz. (250mL)

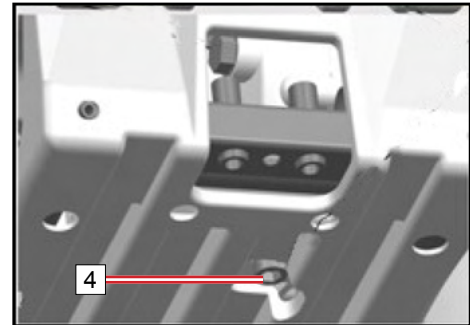
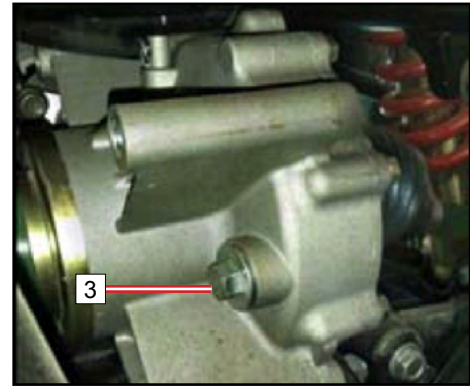

## MAINTENANCE

### Front and rear axles

The front and rear axle dust boots **1** must be checked for holes or wear before operating. If any damage is found, have your dealer check and repair the vehicle.

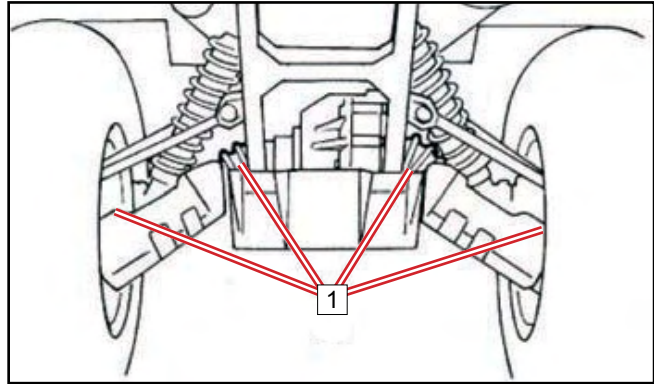
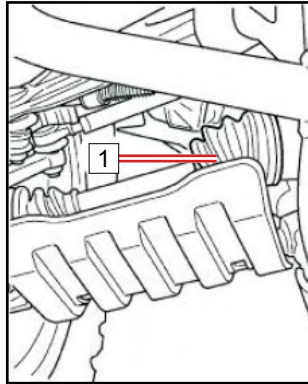
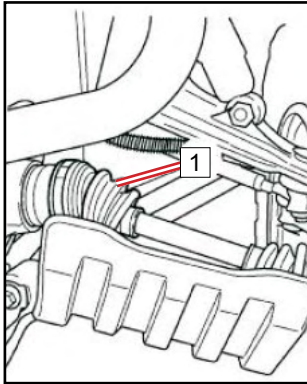

## MAINTENANCE

### CVT system

This vehicle has a Continuously Variable Transmission (CVT) system that utilizes a belt and clutch pulleys to automatically vary transmission ratios, allowing infinite variability between the highest and lowest vehicle speeds with no discrete steps or shifts.

The CVT consists of a primary clutch [1], which is an advanced form of centrifugal clutch that is mounted to the engine crankshaft [A]. The primary clutch also contains a one-way bearing that creates an engine braking feature to slow the vehicle without having to use the hand or foot brake.

The secondary clutch [2] is mounted to the input shaft of the transmission [B] and serves two functions: As a “slave” pulley to the primary clutch, and to provide a torque sensing element. The drive belt [3] is a heavy duty V-belt that connects the engine and transmission pulleys.

A CVT housing and cover encloses the clutches and belt assembly. It has inlet and outlet cooling ducts that route air to cool the components, and they should be inspected. The CVT components do not contain any user maintenance items. Contact your dealer for service.

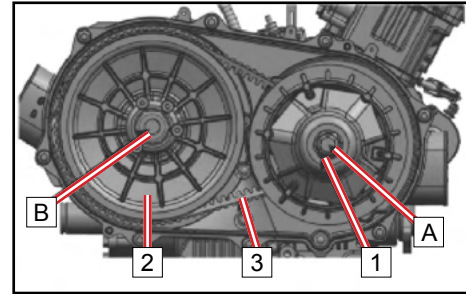

## MAINTENANCE

### Avoiding CVT drive belt and component problems

CVT clutch and belt life can be dramatically extended by avoiding these common operating mistakes:

<b>Causes CVT damage:</b>	<b>Solution:</b>
Attempting to load the vehicle onto a truck bed or tall trailer in high gear.	Shift transmission to low gear during loading of the vehicle to prevent belt burning.
Starting out on a steep incline in high gear.	When starting out on steep inclines, use low gear.
Constant driving at low RPM, driving at just above clutch engagement RPM, or at low speed (approximately 3mph~6mph [5km/h~10 km/h]) in high gear.	Low gear is highly recommended for cooler CVT operating temperatures and longer component life. Drive at a higher speed or use low gear more frequently.
Insufficient warm-up of CVT exposed to low ambient temperatures	Warm the engine before driving, the CVT drive belt will become more flexible and prevent belt burning.
Slow throttle and easy CVT engagement.	Use the throttle with purpose and effectively for efficient CVT clutch engagement.
Towing/pushing at low RPM/low ground speed.	Use low gear only.
Utility use/plowing snow, dirt, etc.	Use low gear only.
Heavy vehicle load operating at low speed	Use low gear only.

## MAINTENANCE

Causes CVT damage:	Solution:
Climbing over large objects from a stopped position.	Shift the transmission to low gear, and carefully use fast, brief, aggressive throttle application to engage the CVT. <b>WARNING:</b> Excessive throttle may cause loss of control and vehicle overturn.
Climbing over large objects from a stopped position.	Shift the transmission to low gear, and carefully use fast, brief, aggressive throttle application to engage the CVT. <b>WARNING:</b> Excessive throttle may cause loss of control and vehicle overturn.
Belt slipping from water or snow ingestion into the CVT system.	Drain the water from the CVT housing and dry the CVT if possible, or contact your dealer.
Overheating of the CVT components causes malfunction.	Contact your dealer for inspection and repair of the CVT components.



## MAINTENANCE

### CVT air outlet check hose

There is a check hose **4** at the bottom of the CVT cooling duct, located at the rear of the engine. If dust or water can be viewed in this hose, empty the hose and clean or drain the CVT housing. If the vehicle was submerged, contact your local dealer to check the CVT housing and components thoroughly.

### CVT housing drain bolt

If the vehicle was submerged in water deep enough that water entered the CVT housing, remove the drain bolt **5** at the bottom of the housing to drain the water from the case.

### **⚠ CAUTION**

If water drains from the V-belt case after removing the bolt, have your dealer inspect the vehicle, as the water may have affected the CVT system and other engine parts.

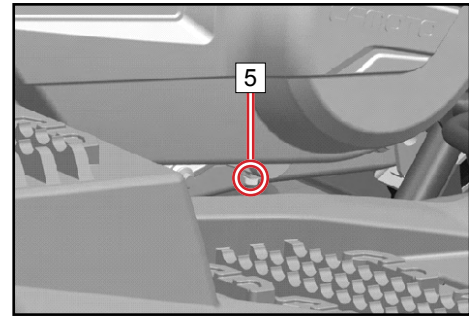
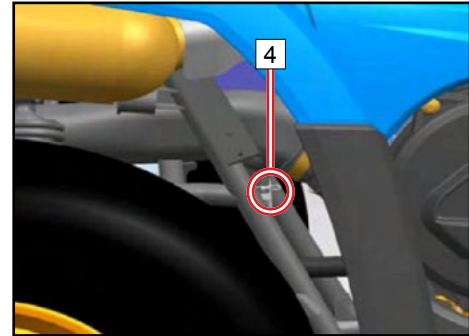

## MAINTENANCE

### Cooling system

#### Coolant level inspection

1. Place the ATV on a level surface.
2. Inspect the coolant level in the reservoir, which can be viewed through a port in the right side inner fender liner **1**.
3. If the coolant is at or below the lower limit mark; remove the access cover and the reservoir cap **2**. Add coolant to the upper limit mark, install the reservoir cap, and then reinstall the access cover.

#### NOTE

Check the coolant level in the coolant reservoir when the engine is cold, as the coolant level will vary with engine temperature.

Coolant system capacity: 2.1 qt. (2.27 L)

Lowest capacity of coolant reservoir: 0.24 qt. (227mL)

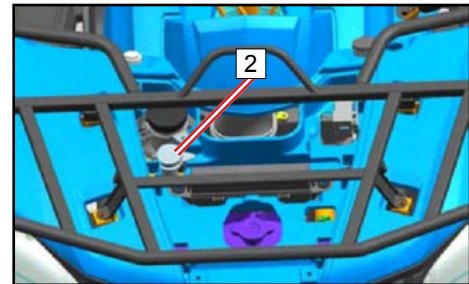
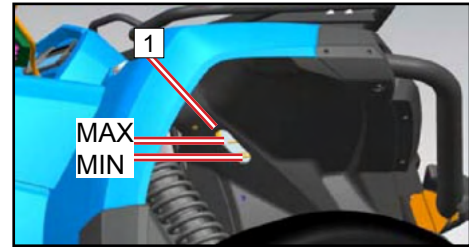

## MAINTENANCE

### **⚠ CAUTION**

If water is added, have your dealer check the antifreeze content of the coolant as soon as possible. Never add hard water or salt water, as it is harmful to the engine. Soft water may be used if distilled water is not available. The radiator fan operation is automatically switched on or off according to the coolant temperature in the radiator during operation.

### **Change the coolant**

#### **⚠ CAUTION**

After running the engine, never remove the radiator cap immediately. Wait for the engine to cool down before removing the radiator cap. Hot coolant can cause serious burns.

1. Place the ATV on a level surface.
2. Remove the front access cover.
3. Remove the radiator cap [3].
4. Remove the coolant reservoir cap [2].
5. Place a container under the engine, and then remove:
  - The small engine left cover [4].
  - The engine left cover [5].
  - The coolant drain bolt [6].

Coolant will begin to drain from the system

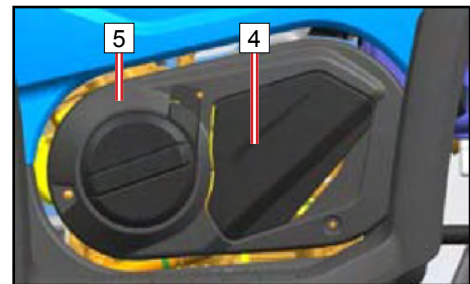
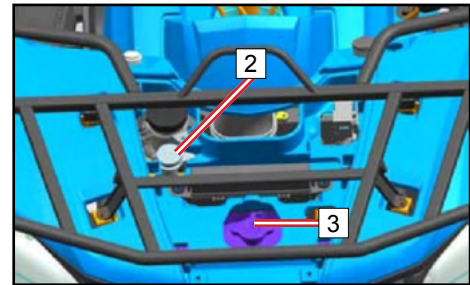

## MAINTENANCE

6. Disconnect the hose from the coolant reservoir, and drain the coolant into a container.
7. After draining the system, thoroughly flush the system with clean tap water. Allow the water to drain completely from the coolant drain.
8. Replace the coolant drain bolt washer if it is damaged, then install and tighten the coolant drain bolt, but do not torque to specification.
9. Reinstall the coolant reservoir hose.
10. Fill the recommended coolant into the radiator until it is full.

### NOTE

When filling coolant, at the same time loosen the coolant drain bolt **6** to draw out potential air bubbles inside the coolant hose until coolant flows out, then tighten the drain bolt to 7.3 ft-lb. (10 N•m).

11. Install the radiator cap.
12. Start the engine and let it idle for several minutes. Stop the engine and allow it to cool. Check the coolant level in the radiator. If it is low, add more coolant until it reaches the top of the radiator. Repeat as necessary.
13. Fill the coolant reservoir with coolant up to the upper limit.

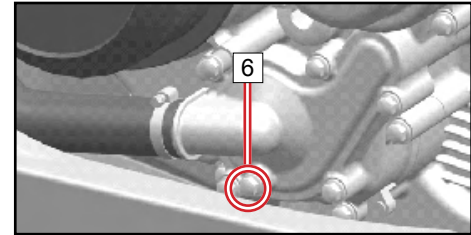

## MAINTENANCE

14. Install the coolant reservoir cap and check for coolant leaks. If any leaks are found, have your dealer check the cooling system.
15. Reinstall:
  - The engine left cover. Tighten the fasteners to 7.3 ft-lb. (10 N•m).
  - The small engine left cover
  - The front access cover

### NOTE

Recommended antifreeze:

Any high quality ethylene glycol antifreeze containing corrosion inhibitors for aluminum engines. Antifreeze and water mixing ratio: 1:1

Coolant capacity: 2.1 qt. (2.27 L)

Coolant change: 2.0 qt. (1.89 L)

Coolant reservoir capacity: 0.24 qt. ~ 0.42 qt. (227mL ~ 397mL)

### Cleaning

Cleaning the external surfaces of the radiator if it is covered with mud or debris will ensure it continues to efficiently cooling the engine. Use only low pressure water to clean the radiator. High pressure washers can damage components. Ensure that the water can flow freely through the radiator fins. This is a sign that cooling air will be allow to pass through.

## MAINTENANCE

### Spark plug

The spark plug is an important engine component that is easy to inspect. The color and condition of the spark plug can indicate the condition of the engine. The ideal color on the insulator around the center electrode is a medium-to-light tan color for an engine that is being operated normally. If electrode erosion becomes excessive, or if carbon and other deposits are excessive, you should replace the spark plug with the specified plug.

Periodically remove and inspect the spark plug for heat damage and deposits that will cause the spark plug to break down and erode. Do not attempt to diagnose spark plug color or engine problems yourself. Instead, take the vehicle to your dealer for service.

### Inspection

1. Remove the left side panel:
  - Remove the seat
  - Remove the 2 bottom screws from the left inner fender
  - Remove the bottom bolt from the side panel
  - Pull the back of the side panel away
  - Rotate the front of the side panel up and away from the body
2. Remove the spark plug cap 1 .

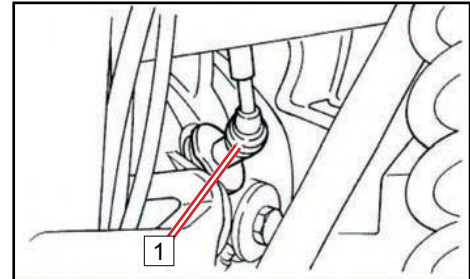

## MAINTENANCE

3. Use the spark plug socket and wrench **2** from the tool kit to remove the spark plug.
4. Check the spark plug gap (A) using a thickness gauge. Adjust the gap if necessary.

### NOTE

Specified spark plug: DCPR8E (NGK)

Spark plug gap: 0.035 in. ~ 0.045 in. (0.8 mm ~ 0.9 mm)

5. Clean the gasket surface. Wipe off any grime from the threads.
6. Install spark plug and tighten to specified torque.

### NOTE

7. Spark plug torque: 14.8 ft-lb (20 N•m). If a torque wrench is not available when you are installing a spark plug, a good estimate of the correct torque is 1/4 to 1/2 turn past finger tight.
8. Install the spark plug cap.
9. Install the side panel. Torque the fasteners to 7.3 ft-lb. (10 N•m).

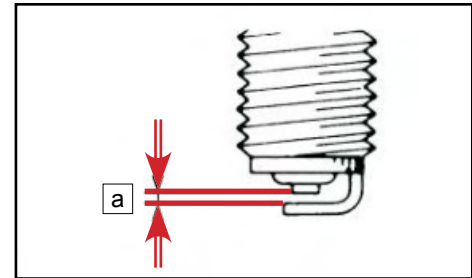
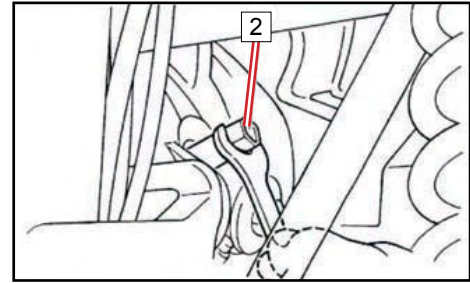

## **MAINTENANCE**

### **Spark plug removal to expel water from the engine**

If water has been ingested into the engine, it is important to remove the water as soon as possible by removing the spark plug and using the starter system to rotate the engine for a short period to expel water out of the cylinder. Verify that the air box has been drained of water before attempting to expel water.

### **CAUTION**

Major engine damage can result if the vehicle if water is ingested into the engine. Have the vehicle serviced by your dealer promptly if your vehicle becomes immersed or stalls in water that exceeds the footrest level. It is important to contact your dealer for service before starting the engine if water has been ingested. Water inside the engine can cause a 'hydraulic lock' effect that can damage the starter and engine components. The engine oil should be checked for water contamination. Drain and refill with new engine oil if water is found in the crankcase.



## MAINTENANCE

### Exhaust spark arrestor

Clean carbon deposits from the spark arrestor while the muffler and exhaust are in normal air temperature.

1. Remove the fasteners **1**.
2. Tap the tailpipe lightly to loosen it and remove the spark arrestor **2** from the muffler.
3. Use a wire brush to remove any carbon deposits from the spark arrestor portion of the tailpipe **3**.
4. Insert the tailpipe into the muffler and align the bolt holes.
5. Install and torque the fasteners to 7.3 ft-lb. (10 N•m).

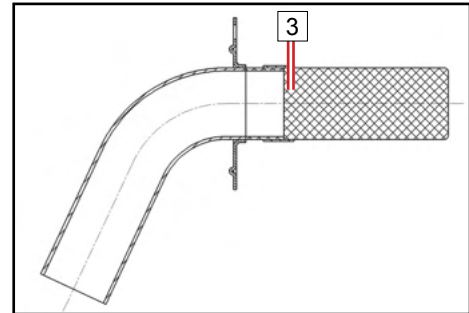
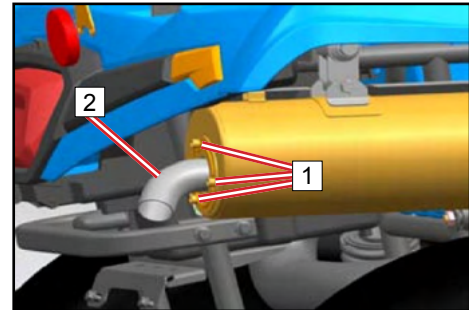

## MAINTENANCE

### Brakes

#### Brake fluid level inspection

Before riding, check that the brake fluid levels are above the lower mark and replenish whenever necessary. Insufficient brake fluid may let air enter the brake system, possibly causing the brakes to become ineffective. The front brake fluid master cylinder reservoir level **A** is located on the right handlebar. The rear brake fluid master cylinder reservoir **B** is under the front rack access panel.

#### Observe these precautions:

- When checking the fluid level, make sure the top of the master cylinder reservoir is level by verifying the handlebars are pointed forward.
- Use only the designated quality brake fluid. Otherwise, the rubber seals may deteriorate, causing leaks and poor brake performance.
- Recommended brake fluid: DOT 4.

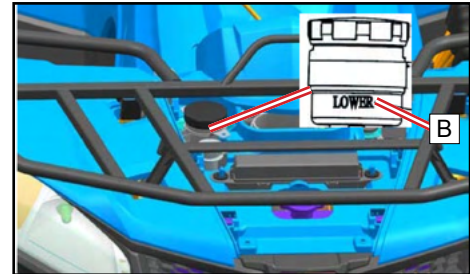
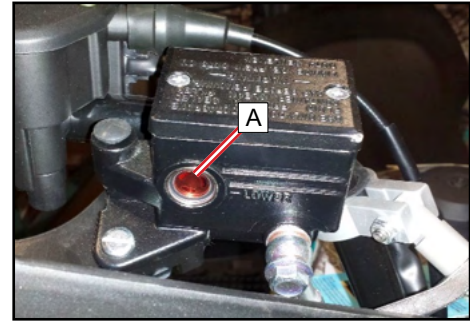

## **MAINTENANCE**

- Refill with the same type of brake fluid. Mixing fluids may result in a harmful chemical reaction and may lead to poor brake performance.
- Be careful that water does not enter the master cylinder reservoir when refilling. Water will significantly lower the boiling point of the fluid and lead to poor brake performance.
- Brake fluid may deteriorate painted surfaces or plastic parts. Always clean up spilled fluid immediately.
- Have your dealer check the cause if the brake fluid level goes down unexpectedly.

### **Brake fluid change**

Complete fluid replacement should be done only by trained service personnel. Have your dealer replace the following components during periodic maintenance, or when they are damaged or leaking:

- Replace the seals every two (2) years
  
- Replace the brake hoses every four (4) years

## MAINTENANCE

### Front brake pad inspection

Inspect the front brake pads and discs for damage and wear. If the pad thickness **A** is less than 0.059 in. (1.5mm) or the disc thickness **B** is less than 0.118 in. (3.0mm), have your dealer replace them. Replacement of brake components requires professional knowledge. These procedures should be performed by your dealer.

### NOTE

Wheels must be removed to check brake pads.

### ⚠ CAUTION

After servicing:

- Make sure the brakes operate smoothly and that the lever free play is correct.
- Make sure the brakes do not drag and the brake operation is not spongy.
- All air is bled from the brake system.

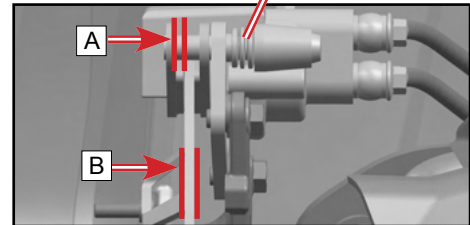
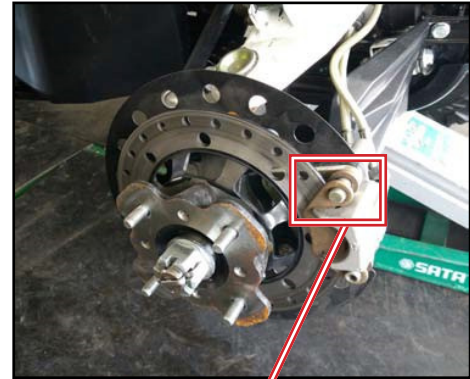

## MAINTENANCE

### Rear brake pad inspection

Inspect the rear brake pads and brake disc for damage and wear. If the pad thickness **A** is less than 0.059 in. (1.5mm) or the disc thickness **B** is less than 0.256 in. (6.5mm) have your dealer replace them. Replacement of brake components requires professional knowledge. These procedures should be performed by your dealer.

### CAUTION

After servicing:

- Make sure the brakes operate smoothly and that the lever free play is correct.
- Make sure the brakes do not drag and the brake operation is not spongy.
- All air is bled from the brake system.

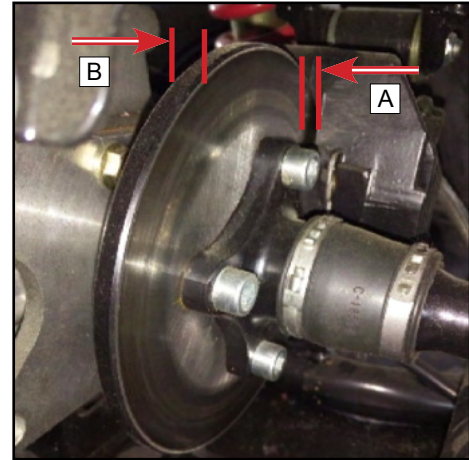

## MAINTENANCE

### Front brake lever freeplay

The front brake lever **A** should have zero in. (zero mm) free play of at the lever end. If free play is present, have your dealer check the brake system.

### Foot brake pedal height

The top of the brake pedal should be positioned 2.75 in. ~ 3.14 in. (70mm~80mm) above the top of the footrest. If it is not, ask your dealer to adjust it.

### NOTE

Inspect the rear brake pad thickness before adjusting the foot brake.

### Brake light switch operation

The brake light switch, which is activated by the foot brake pedal and front brake lever, is properly adjusted when the brake light comes on just before braking takes effect. Check the switch assembly, or that the cable is properly fixed in case of brake light failure.

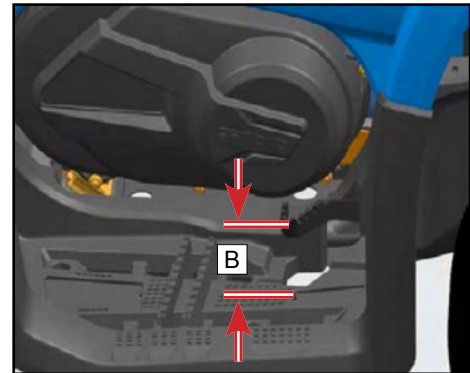
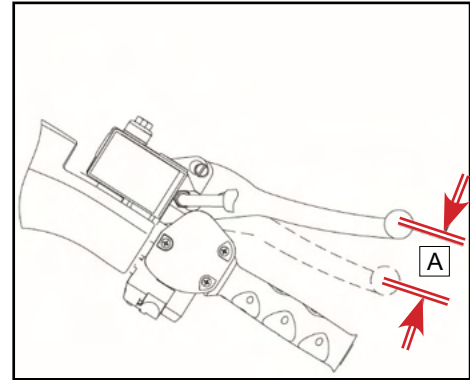

## **MAINTENANCE**

### **Control Cables**

#### **Inspection and lubrication**

Inspect cables frequently. Lubricate the inner cable and the cable ends. Replace damaged cables. If the cables do not operate smoothly, ask your dealer to replace them.

#### **NOTE**

Recommended lubricant: SAE 10W-30 or a commercially available cable lubricant.

## MAINTENANCE

### Suspension

#### Front suspension lubrication

The front suspension of the vehicle contains components that require no maintenance or lubrication. Ensure the components are cleaned regularly, and are not loose or damaged before operating the vehicle.

#### Rear suspension lubrication

Lubricate the upper and lower pivots of the rear axles:

1. Remove the rear wheels 1.
2. Add grease into the grease nipples 2 at the upper and lower pivots with a grease gun.
3. Reinstall the rear wheels. Torque the fasteners to specification.

#### NOTE

Recommended lubricant: All Season Grease

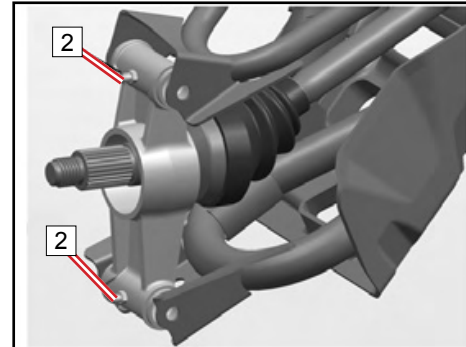



## MAINTENANCE

### Spring preload adjustment

The front and rear suspension adjustment spring preload can be adjusted to suit the rider's weight and riding conditions.

Adjust the spring preload as follows.

To increase the spring preload, turn the adjusting ring **1** in Direction **'A'**.

To decrease the spring preload, turn the adjusting ring **1** in Direction **'B'**.

Standard Suspension Setting **2**: **B**

A = Minimum (soft)~E = Maximum (hard)

### NOTE

A special collar wrench **C** can be obtained at a dealer to make preload adjustments.

Always adjust the shock absorbers on the left and right side to the same setting.

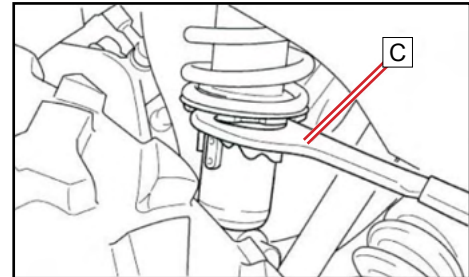
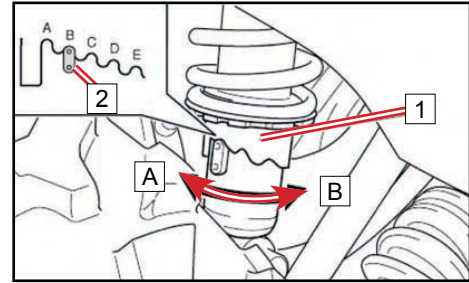

## MAINTENANCE

### Wheels

#### Tire pressure

Inspect the tire pressure before operation:

Front: 8.0 psi (56 kPa)

Rear: 6.0 psi (42 kPa)

#### Tread depth

Inspect the tread depth regularly and replace the tires if the minimum tread depth is less than:

Minimum tread depth: 3/32 in. (3.0 mm)

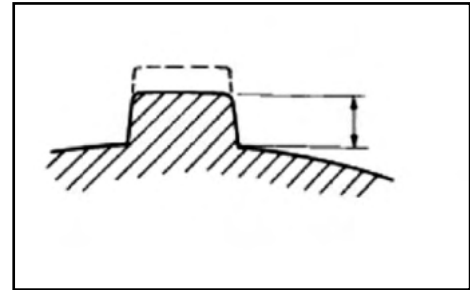
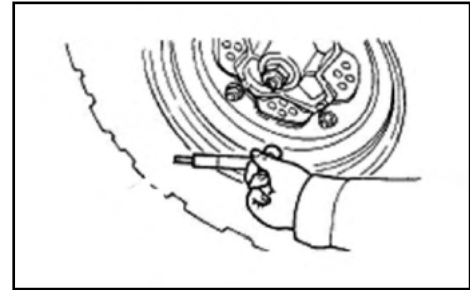

## MAINTENANCE

### Wheel Removal

1. Ensure vehicle is in park.
2. Loosen the wheel fasteners **1** .
3. Elevate the vehicle and place a suitable support stand under the frame.
4. Remove the fasteners from the wheel.
5. Remove the wheel.

### Wheel Installation

1. Ensure vehicle is in park.
2. Install the wheel.
3. Install the wheel fasteners hand tight.
4. Elevate the vehicle, remove the support stand under the frame, and lower the vehicle to the ground.
5. Torque the wheel fasteners to specification:
  - Steel wheels: 37 ft-lb. ~ 44 ft-lb. (50 N•m ~ 60 N•m)
  - Aluminum wheels: 52 ft-lb. ~ 59 ft-lb. (70 N•m ~ 80 N•m)

### NOTE

For steel or aluminum wheels, install the fastener with the tapered surface facing the wheel.



## MAINTENANCE

### Electrical

#### Head light assembly

Front turning light **1** (If equipped)

Head light **2**

Daytime running light **3**

**NOTE:** **3** is an LED assembly integrated into the structure, and cannot be fixed if there is any failure. The housing must be replaced.

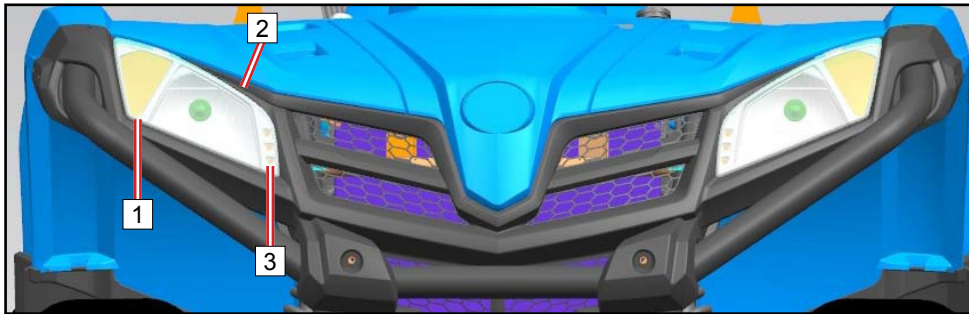

## MAINTENANCE

### Electrical

#### Head light adjustment

1. Access the head light adjusters:
  - Remove the screw [1], and plastic clamps [2] from the inner fender panel.
  - Remove the panel [3] to expose the head light housing.
2. Turn the adjusting screws [4] to adjust the direction of the head light low beam and high beam vertically and horizontally.
3. Test the vehicle to ensure that the headlight adjustment is satisfactory.
4. Reinstall the inner fender panel, plastic clamps and screw.

#### **⚠ WARNING**

It is advisable to have your dealer perform headlight adjustments. Improper adjustment could lead to an accident resulting in serious injury or death.

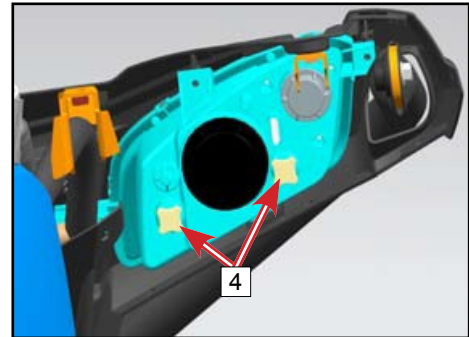
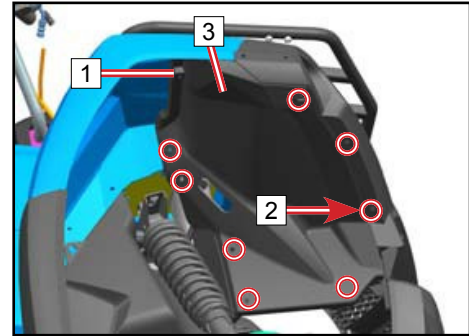

## MAINTENANCE

### Head light replacement

1. Access the head light bulb:
  - Remove the screw [1], and plastic clamps [2] from the inner fender panel.
  - Remove the panel [3] to expose the head light housing.
2. Turn the bulb access cover [5] 60 degrees anti-clockwise and remove it from the housing.
3. Turn the lamp holder [6] 60 degrees anti-clockwise and remove the lamp holder from the head light housing.
4. Remove the failed bulb and replace it with a new bulb.
5. Reinstall the lamp holder into the headlight housing.
6. Test the bulb and ensure it is working properly.
7. Bulb Specification (head light): **HS1 35W×2**

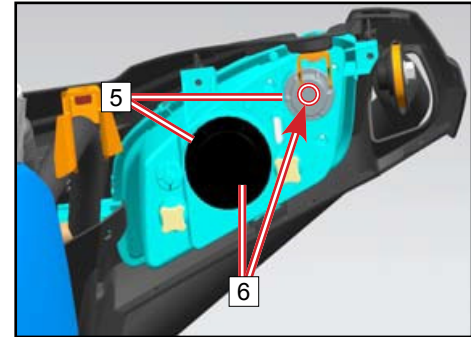

### **⚠ CAUTION**

Hot surface. Touch the bulb only after it has cooled down.

## MAINTENANCE

### Tail lamp replacement

1. Access the tail light bulb:
  - Open the rear access cover.
  - Remove the inner cover fasteners [1].
  - Push the tail lamp assembly [2] out of the cover to expose the housing.
  - Turn the bulb access cover [3] 60 degrees anti-clockwise and remove it from the housing.
2. Remove the fasteners #3 from the inner cover.
3. Remove the failed assembly [4] and replace it with a new one.
4. Reinstall the lamp holder into the tail lamp housing.
5. Test the bulb and ensure it is working properly.
6. Reinstall the tail lamp housing and fasteners onto the access cover. Tighten the fasteners to **7.3 ft-lb. (10 N•m)**.
7. Bulb Specification: **12V 21/5W**

### **⚠ CAUTION**

Hot surface. Touch the bulb only after it has cooled down.

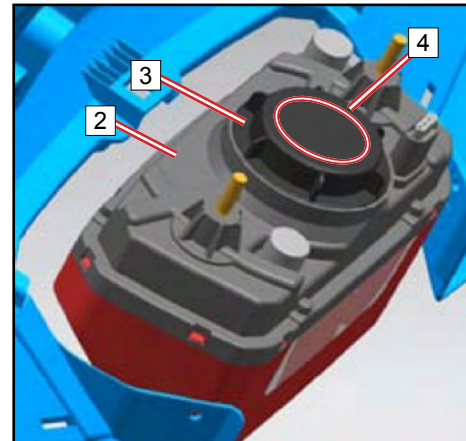
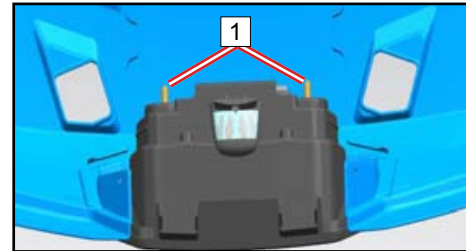

## MAINTENANCE

### License plate lamp replacement

If the license plate lamp has failed:

1. Pull the lamp holder from the rear of the license plate lamp housing.
2. Pull the failed bulb and replace it with a new bulb.
3. Reinstall the lamp holder into the rear of the license plate lamp housing.
4. Bulb Specification: **12V 5W W5W**

### CAUTION

Hot surface. Touch the bulb only after it has cooled down.

### Fuses and relays

The main relays and fuses are located under the front access cover. If a fuse is blown, turn off the main switch and install a new fuse of the specified amperage. Turn on the main switch. If the fuse immediately blows again, consult your dealer. For relay replacement, consult your dealer.

### CAUTION

To prevent an accidental short-circuit, turn off the main switch when checking or replacing fuses. Always use a fuse with the correct specified rating. Never use conductive material in place of the proper fuse.



## MAINTENANCE

### Relays

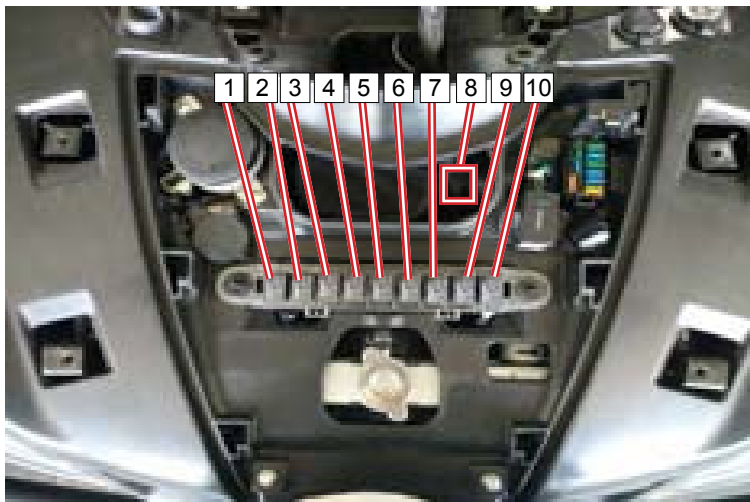

1	Auxiliary Relay	4	4WD LOCK Relay	7	Low Beam Relay	10	Unused
2	Fuel Pump Relay	5	2x4 Relay	8	Winch Control Relay (if equipped)		
3	Brake Relay	6	Fan Relay	9	High Beam Relay		

## MAINTENANCE

### Fuses

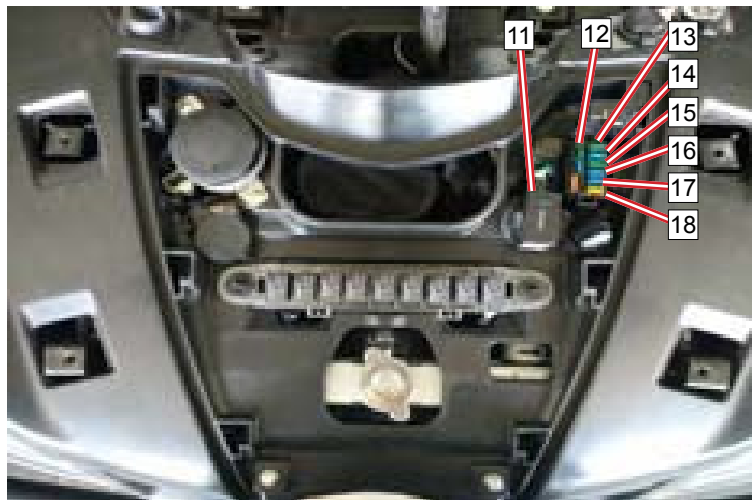

11	Flash	14	Unused	17	Fan Fuse (15A)
12	Spare Fuses	15	Signal / Fuel Pump Fuse (15A)	18	Headlight Fuse (15A)
13	Oxygen Sensor Fuse (5A)	16	Start Relay Fuse (15A)		

# MAINTENANCE

## Electrical component locations

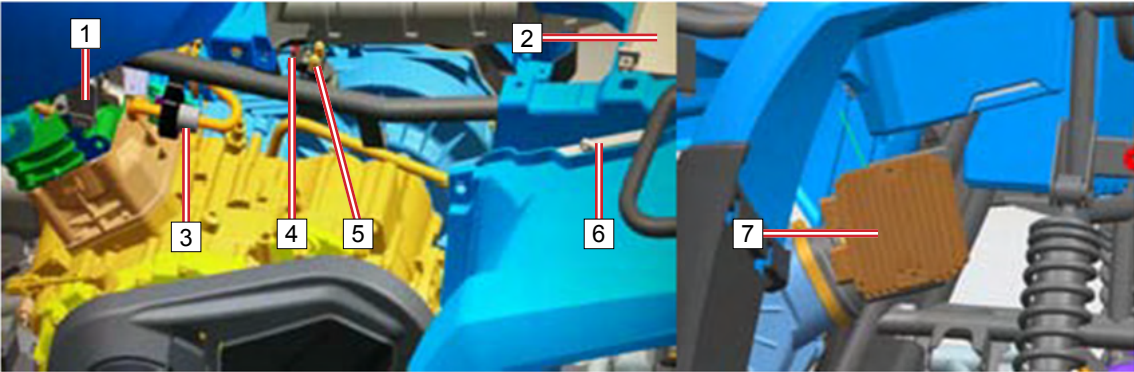

1	High Tension Ignition Coil	4	Fuse (20A)	7	Regulator / Rectifier
2	Battery	5	Start Relay		
3	Idle Valve	6	ECU		

## **MAINTENANCE**

### **Cleaning and Storage**

#### **Washing the vehicle**

Keeping your vehicle clean will not only improve its appearance, but it can also extend the life of various components. With a few precautions, your vehicle can be cleaned much like an automobile:

- The best and safest way to clean your vehicle is with a garden hose and a pail of mild soap and water. Harsh detergents may deteriorate rubber components.
- Use a professional type washing mitten, cleaning the upper body first and the lower parts last.
- Pay special attention that the cooling system radiator and axle boots are thoroughly cleaned of all dirt and debris.
- Rinse with water frequently and dry the vehicle with a chamois to prevent water spots.
- Lubricate all pivot points immediately after washing.
- Allow the engine to run for a while to evaporate any water that may have entered the engine air intake or exhaust system.

CFMOTO does not recommend the use of a high pressure type car wash system for washing your vehicle, as water can be forced past seals. If a high pressure system is used, exercise extreme care to avoid water damage to the decals, wheel bearings, transmission seals, body panels, brakes, warning labels, air filter intake system and electrical system. Ensure water is not allowed to enter into the air filter housing. If warning and safety labels are damaged, contact your dealer for a replacement.

## **MAINTENANCE**

### **Waxing the vehicle**

Your vehicle can be waxed with any non-abrasive automotive paste wax. Avoid the use of harsh cleaners since they can scratch the body finish.

### **CAUTION**

Certain products, including insect repellants and other chemicals, will damage plastic surfaces. Use caution when using these products near plastic surfaces

### **Perform repairs**

Make necessary repairs to your vehicle before storing to prevent further damage the next time you operate it.

### **Check the tires**

Inspect the tire treads and overall condition. Set the tires to the specified air pressure.

### **Oil and filter**

Warm the engine, then stop the engine and change the oil and filter.

### **Air filter/ Air box**

Inspect and clean or replace air filter. Clean the air box and the sediment tube.

## **MAINTENANCE**

### **Check fluid levels**

Inspect the following fluid levels and change if necessary:

- Front gear case
- Rear gear case
- Brake fluid (change every two years or as required if fluid looks dark or contaminated)
- Coolant (change every two years or as required if coolant looks contaminated)
- Fuel Level (add fuel stabilizer according to the product label directions)

### **Stabilize the fuel**

Fill the fuel tank with fresh fuel that has been treated with fuel stabilizer according to the product label directions. Do not allow untreated fuel to remain in the tank longer than 30 days, as the fuel begins to degrade and can cause damage to the fuel system components.

### **Battery storage**

Remove the battery from the vehicle and ensure that it is fully charged before placing it in storage. Protect the battery from freezing temperatures, which can damage the battery.

### **Lubricate**

Inspect all cables and lubricate with cable lubricant according to the product label directions. Grease the vehicle pivot points with all season grease.

## MAINTENANCE

### 'Fog' the engine

1. Remove the left side panel to access the spark plug.
2. Remove the spark plug, rotate the piston to the bottom of its stroke and pour approximately 2.0 oz. (15mL~20mL) of SAE 5W~40/SG engine oil into the opening.

### NOTE

Do this carefully! If you miss the spark plug hole, oil will drain from the spark plug cavity, and appear to be an oil leak. To access the spark plug hole, use a section of clean hose and a small plastic squeeze bottle filled with the pre-measured amount of oil.

3. Reinstall the spark plug. Torque the spark plug to specification.
4. Turn engine over several times slowly. Oil will be forced in and around the piston, piston rings and the cylinder will be coated with a protective film of fresh oil.
5. Reinstall the spark plug cap and side panel.

### NOTE

Starting the engine during the storage period will disturb the protective film created by fogging. Corrosion could occur. Never start the engine during the storage period.

## MAINTENANCE

### Storage area and covering

Support the vehicle with stands under the frame with the tires 30 mm ~ 40 mm (1/2 in.) off the ground. Be sure the storage area is well ventilated, and cover the machine with an approved cover.

### NOTE

Do not use covers made of plastic or coated materials. They do not allow enough ventilation to prevent condensation, and may promote corrosion and oxidation.

### Transporting the vehicle

Follow these procedures when transporting the vehicle:

- Turn off the engine and remove the key to prevent loss during transporting.
- Place the gear selector into any position except the parking position, and block the front and rear wheels to prevent the vehicle from moving.
- Ensure the fuel cap is installed correctly and secure.
- Ensure the seat is installed correctly and secure.
- Secure the front and rear vehicle frame to the transporting device. This will prevent the vehicle from sliding or moving during transport.

### CAUTION

Never transport with the gear selector in the parking position. Damage to the engine and transmission may result.



## Vehicle Issue Diagnosis

This section is intended to guide an average owner to simple items that could cause operating problems. Diagnosis of vehicle issues may require the experience of a dealership technician. Please contact your dealer if a solution is not apparent.

### Engine doesn't turn over

Possible Cause	Solution
Blown fuse	Reset or replace the fuse
Low battery voltage	Recharge battery to 12.8 Vdc – Confirm battery state of health
Loose battery connections	Check all connections and tighten if necessary
Loose starter system electrical connections	Check all connections and tighten if necessary
Engine stop switch	Check function
Start circuit not complete – transmission in gear	Press foot brake or shift transmission to neutral or parking position.

### Engine pings or knocks

Possible Cause	Solution
Poor quality or low octane fuel	Replace with minimum 89 octane unleaded fuel
Incorrect ignition timing.	See your dealer
Incorrect spark plug gap or heat range	Set spark plug gap to specs or replace plugs

## VEHICLE DIAGNOSIS

### Engine stops or loses power

Possible Cause	Solution
Overheated engine	Clean radiator screen and external core; clean engine exterior; See your dealer
Out of fuel	Refuel with minimum 89 octane unleaded fuel
Kinked or plugged fuel tank vent line	Inspect and replace; See your dealer
Water present in fuel	Replace with new fuel
Fouled or defective spark plugs	Inspect and clean or replace spark plug
Worn or defective spark plug wires	See your dealer
Incorrect spark plug gap or heat range	Set gap to specs or replace plug
Loose ignition connections	Check all connections and tighten
Low battery voltage	Recharge battery to 12.8 Vdc; check charging system – Confirm battery health
Clogged air filter	Inspect and replace as necessary
Reverse speed limiter malfunction	See your dealer
Electronic throttle control malfunction	See your dealer
Other mechanical failure	See your dealer

## VEHICLE DIAGNOSIS

### Engine turns over, Fails to start

Possible Cause	Solution
Out of Fuel	Refuel
Clogged fuel filter	Inspect and replace as necessary
Water is present in fuel	Replace with 89 minimum octane unleaded fuel
Fuel pump is inoperative	Inspect pump and fuse; Replace as necessary
Old or non-recommended fuel	Replace with 89 minimum octane unleaded fuel
Fouled or defective spark plug(s)	Inspect spark plug(s), replace if necessary
No spark to spark plug	Inspect spark plug( s) , verify stop switch is on
Crankcase filled with water or fuel	Immediately see your dealer
Clogged air filter	Inspect and replace as necessary; Replace spark plugs as necessary
Clogged fuel injector	See your dealer
Low battery voltage	Recharge battery to 12.8 Vdc – Confirm battery health
Mechanical failure	See your dealer

## VEHICLE DIAGNOSIS

### Engine backfires

Possible Cause	Solution
Weak spark from spark plugs	Inspect and replace spark plugs as necessary
Incorrect spark plug gap or heat range	Set gap to specs or replace plugs
Old or non-recommended fuel	Replace with minimum 89 octane unleaded fuel
Incorrectly installed spark plug wires	See your dealer
Incorrect ignition timing	See your dealer
Mechanical failure	See your dealer
Speed limiter malfunction	See your dealer

### Engine runs irregularly, stalls or misfires

Possible Cause	Solution
Fouled or defective spark plugs	Inspect and replace spark plugs as necessary
Worn or defective spark plug wires	See your dealer
Incorrect spark plug gap or heat range	Set gap to specs or replace plugs
Loose ignition connections	Check all connections and tighten
Water present in fuel	Replace with new fuel
Low battery voltage	Recharge battery to 12.8 Vdc; Check charging system
Kinked or plugged fuel tank vent line	Inspect and replace
Incorrect fuel	Replace with 89 minimum octane unleaded fuel
Clogged air filter	Inspect and replace as necessary; Replace spark plugs as necessary

## VEHICLE DIAGNOSIS

Possible Cause	Solution
Reverse speed limiter malfunction	See your dealer
Electronic throttle control malfunction	See your dealer
Other mechanical failure	See your dealer
Possible Lean or Rich fuel mixture	See your dealer
Low or contaminated fuel	Add or change fuel, clean the fuel system
Low octane fuel	Replace with minimum 89 octane unleaded fuel
Clogged fuel filter	Replace filter
Fuel is very high octane	Replace with minimum 89 octane unleaded fuel

## VEHICLE DIAGNOSIS

### EFI Malfunction Indicator Light

The fuel injection system on your vehicle contains a self-diagnostic feature that will present a series of 4-digit flashes of the malfunction indicator light (MIL) if it detects a problem. Stop operating the vehicle and contact your dealer immediately if the EFI system MIL is illuminated.

#### Example: CODE '0650'

- '0' - light flashes 10 times
- '6' - light flashes 6 times
- '5' - light flashes 5 times
- '0' - light flashes 10 times

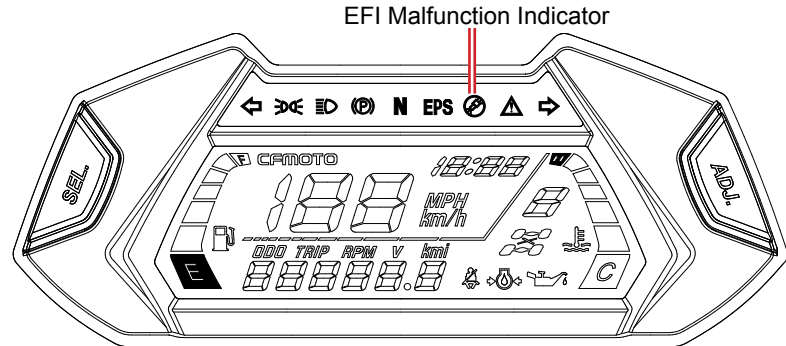

If there are multiple codes detected, the system will wait approximately 3 seconds and display the next code. Any codes displayed will disappear once the problem has been diagnosed and repaired by your dealer.

## Warranty Information for USA

### Change of Ownership

If you sell your vehicle, any valid remainder of the warranty can be transferred to the new owner. Please record the details of the exchange below and inform an authorized CFMOTO dealer:

<b>Change of Ownership</b>	<b>Original Purchaser</b>	<b>2<sup>nd</sup> Owner</b>	<b>3<sup>rd</sup> Owner</b>	<b>4<sup>th</sup> Owner</b>
Owner Name				
Address				
City				
State / Zip Code				
Telephone				
E-mail				
Date of Purchase				
Odometer Reading				
New Owner Signature				

#### **NOTE**

If the details contained in the Change of Ownership form do not include the required details or are inaccurate, CFMOTO reserves the right to investigate the actual ownership of the product, the service history, and possibly refuse the application for warranty transfer if the requirements have not been fulfilled.

## **WARRANTY INFORMATION FOR USA**

### **CFMOTO Limited Warranty**

Dear Customer,

Thank you for purchasing a CFMOTO product, if any component on your vehicle is found to be defective in materials or workmanship within the terms and conditions of this Limited Warranty, the defective component will be repaired or replaced (at the option of CFMOTO) without charge for parts and/or labor at any authorized dealer located within the United States. The CFMOTO Limited Warranty is subject to the following terms and conditions:

#### **WARRANTY TERMS & CONDITIONS**

1. **WARRANTY DURATION:** The duration of the warranty period is one (1) year from the date of the new vehicle purchase from an authorized CFMOTO POWERSPORTS, Inc., Dealer. This warranty coverage is invoked from the purchase and use of CFMOTO vehicles only within the continental United States. During the warranty period, CFMOTO POWERSPORTS, Inc. will cover parts and labor costs incurred by an authorized CFMOTO POWERSPORTS, Inc. Dealer arising from a defect in material and/or workmanship of a CFMOTO vehicle. Any vehicles used for commercial purposes will have their warranty period reduced to six (6) months. If CFMOTO POWERSPORTS, Inc. covers a full engine replacement or a complete vehicle replacement under this warranty, the warranty period does not get extended and remains the same as the original purchase date of the vehicle at issue.

2. **WARRANTY LIMITATIONS:** CFMOTO POWERSPORTS, Inc. provides warranty coverage for one (1) year on all parts and labor for all of its new CFMOTO ATVs. However, the following coverage, exceptions, and limitations apply to all CFMOTO vehicles:



## **WARRANTY INFORMATION FOR USA**

- A. A 30-DAY WARRANTY coverage period applies to all new CFMOTO vehicles in relation to the vehicle's:
- Battery
  - Spark Plugs
  - Air Filters
  - Oil and Fuel Filters
- B. A 90-DAY WARRANTY coverage period applies to all new CFMOTO vehicles in relation to the vehicle's:
- Drive Belt
  - Gear Shift, CVT, and Wet Clutch
  - Throttle and Brake Cables
  - Front/Rear Rims
  - Front/Rear Tires
  - Front/Rear Brake Pads or Shoes
  - Front/Rear Brake Discs or Drums
  - Wheel or Steering Stem Bearings and Seals
  - Rubber Parts/Engine Mounts/Grips/Boots
  - Brake or Clutch Levers
  - Floor Boards or Pegs
  - ATV Winch (if equipped)
  - Light Bulbs/Fuses
  - Body Plastics and Cosmetic Defects

## **WARRANTY INFORMATION FOR USA**

3. **EXCLUSIONS FROM WARRANTY COVERAGE:** Any Damage resulting from the following acts or circumstances is not covered by the CFMOTO POWERSPORTS, Inc., Limited Warranty:

- Fire
- Collision
- Theft
- Unavoidable natural disasters
- Improper storage or transportation
- Failure or negligence in the performance of periodic vehicle maintenance
- Improper or negligent use or operation
- Unauthorized repair or adjustment
- Unauthorized modifications or performance upgrades
- Use of vehicle as a rental vehicle
- Use of vehicle in competitive or racing events

4. **VEHICLE CARE AND MAINTENANCE:** The vehicle's owner must properly use, maintain, and care for the vehicle as outlined in the CFMOTO POWERSPORTS, Inc., Owner's Manual. Any warranty repairs must be performed exclusively by CFMOTO POWERSPORTS, Inc., authorized Dealers. Any warranty work performed by anyone other than an authorized CFMOTO Dealer will not be covered under the CFMOTO POWERSPORTS, Inc., Limited Warranty policy.

## WARRANTY INFORMATION FOR USA

5. TRANSFER OR CONTINUATION OF WARRANTY: This warranty is transferable only under the following conditions:

- Transfer information must be provided to an authorized CFMOTO POWERSPORTS, Inc. dealer, who will then forward the information to CFMOTO POWERSPORTS, Inc.;
- The complete model and serial number as shown on the original warranty document must be Provided.
- The name and address of the existing and new owners must be provided.
- The original delivery date of the vehicle must be provided.
- The new owner must indicate in writing that he/she has received and read the vehicle's Owner's Manual and the CFMOTO POWERSPORTS, Inc. Warranty Policy.

6. WARRANTY REGISTRATION: The Dealer must complete a PDI form and warranty register the vehicle online and provide the completed registration form to CFMOTO POWERSPORTS, Inc., within seven (7) days of completing the sale of the vehicle. Please note that NO warranty claims will be processed unless the product warranty online registration form is completed and the form is received by CFMOTO POWERSPORTS, Inc., from the Dealer.

7. DEALER RESPONSIBILITIES: A CFMOTO authorized Dealer must perform warranty coverage repairs at no charge to the customer, even if they are not the dealer that sold the CFMOTO vehicle to the customer and must use CFMOTO OEM parts for all warranty repairs. All vehicles sold by the dealer must be inspected and tested by the dealer to ensure proper performance and operation prior to delivery to the customer. No vehicles may be delivered to a customer without first passing a dealer inspection and an operational test.

## **WARRANTY INFORMATION FOR USA**

8. **CUSTOMER ASSISTANCE:** Any questions regarding your CFMOTO vehicle or related products should be directed to an authorized CFMOTO dealer. However, if a dealer is not available to answer customer concerns, or address a technical issue with a CFMOTO vehicle or product, CFMOTO POWERSPORTS, Inc., customer representatives can be contacted directly at (763) 398-2690 or e-mail: [info@cfmoto-us.com](mailto:info@cfmoto-us.com).
9. **COMMERCIAL USE.** The duration of the warranty for commercial use shall be limited to a period of six (6) months instead of one year for recreational use. All other conditions and limitations shall apply.
10. **TIRES PROVIDED AS ORIGINAL EQUIPMENT:** Other than provided herein, vehicle tires supplied as original equipment are warranted separately by the individual tire manufacturer or its representatives.
11. **DISCLAIMER:** NO EXPRESS WARRANTY IS PROVIDED BY CFMOTO POWERSPORTS, INC. WITH RESPECT TO CFMOTO VEHICLES EXCEPT AS SPECIFICALLY SET FORTH HEREIN. ANY IMPLIED WARRANTY, WARRANTY OF MERCHANTABILITY, WARRANTY OF FITNESS FOR A PARTICULAR PURPOSE, AND ALL IMPLIED WARRANTIES ARISING FROM A COURSE OF DEALING, USAGE OF TRADE, BY STATUTE OR OTHERWISE, ARE HEREBY STRICTLY LIMITED TO THE TERMS OF THIS WRITTEN LIMITED WARRANTY.

## **WARRANTY INFORMATION FOR USA**

12. INTEGRATION: This limited warranty supersedes any and all oral, express, or written warranties, statements, or undertakings that may previously have been made, and contains the entire agreement of the parties with respect to the warranty of CFMOTO vehicles. Any and all warranties not contained in this Agreement are specifically excluded. This warranty extends to each original (and subsequent) owner of any CFMOTO ATV, for the term of the original warranty period. This limited warranty shall be the sole and exclusive remedy available to the customer with respect to the covered CFMOTO vehicle. In the event of any alleged breach of any warranty or any legal action brought by the customer based on alleged negligence or other conduct by CFMOTO POWERSPORTS Inc., or its related parties, the customer's sole and exclusive remedy will be repair or replacement of defective components as stated above, unless otherwise provided by law. Some states do not allow limitations on how long an implied warranty lasts, so the above limitations may not apply if they are deemed inconsistent with the controlling state law.

## **WARRANTY INFORMATION FOR USA**

### **U.S.A. EPA and CARB Emissions Control Limited Warranty**

This emissions limited warranty is in addition to the CFMOTO Powersports, Inc. standard limited warranty for your vehicle. CFMOTO Powersports, Inc. warrants that at the time it is first purchased, this emissions-certified vehicle is designed, built and equipped so it conforms to applicable U.S. Environmental Protection Agency (EPA) and the California Air Resource Board (CARB) emission regulations. CFMOTO Powersports, Inc. also warrants that the vehicle is free from defects in materials and workmanship that would cause it to fail to meet these regulations.

The warranty period for this emissions-certified vehicle starts on the date the vehicle is first purchased and continues for a period of 500 hours of engine operation, 5000 kilometers (3,100 miles) of vehicle travel, or 30 calendar months from the date of purchase, whichever comes first. This emissions limited warranty covers components whose failure increases the vehicle's regulated emissions, and it covers components of systems whose only purpose is to control emissions. Repairing or replacing other components not covered by this warranty is the responsibility of the vehicle owner. This emissions limited warranty does not cover components whose failure does not increase the vehicle's regulated emissions.

## **WARRANTY INFORMATION FOR USA**

For exhaust emissions, emission-related components include any engine parts related to the following systems:

- Air-induction system (excludes filters)
- Fuel system (excludes filters)
- Ignition system (excludes spark plugs)
- Exhaust gas recirculation systems

The following parts are also considered emission-related components for exhaust emissions:

- After treatment devices
- Crankcase ventilation valves
- Sensors
- Electronic control units

The following parts are considered emission-related components for evaporative emissions:

- Fuel Tank
- Fuel Cap
- Fuel Line
- Fuel Line Fittings
- Clamps\*
- Pressure Relief Valves\*
- Control Valves\*
- Control Solenoids\*
- Electronic Controls\*
- Vacuum Control Diaphragms\*
- Control Cables\*
- Control Linkages\*
- Purge Valves
- Vapor Hoses
- Liquid/Vapor Separator
- Carbon Canister
- Canister Mounting Brackets
- Carburetor Purge Port Connector

\* As related to the evaporative emission control system.

The exclusive remedy for breach of this limited warranty shall be, at the exclusive option of CFMOTO Powersports, Inc., repair or replacement of any defective materials, components or products.

## **WARRANTY INFORMATION FOR USA**

THE REMEDIES SET FORTH IN THIS LIMITED WARRANTY ARE THE ONLY REMEDIES AVAILABLE TO ANY PERSON FOR BREACH OF THIS WARRANTY. CFMOTO POWERSPORTS, INC. SHALL HAVE NO LIABILITY TO ANY PERSON FOR INCIDENTAL, CONSEQUENTIAL OR SPECIAL DAMAGES OF ANY DESCRIPTION, WHETHER ARISING OUT OF EXPRESS OR IMPLIED WARRANTY OR ANY OTHER CONTRACT, NEGLIGENCE OR OTHER TORT OR OTHERWISE. THIS EXCLUSION OF CONSEQUENTIAL, INCIDENTAL, AND SPECIAL DAMAGES IS INDEPENDENT FROM AND SHALL SURVIVE ANY FINDING THAT THE EXCLUSIVE REMEDY FAILED OF ITS ESSENTIAL PURPOSE.

ALL IMPLIED WARRANTIES (INCLUDING BUT NOT LIMITED TO ANY IMPLIED WARRANTIES OF MERCHANTABILITY AND FITNESS FOR A PARTICULAR PURPOSE) ARE LIMITED IN DURATION TO THE WARRANTY PERIOD DESCRIBED HEREIN. CFMOTO POWERSPORTS, INC. DISCLAIMS ALL EXPRESS WARRANTIES NOT STATED IN THIS WARRANTY.



## **WARRANTY INFORMATION FOR USA**

Some states do not allow limitations on how long an implied warranty lasts, so the above limitation may not apply if it is inconsistent with the controlling state law. This limited warranty excludes failures not caused by a defect in material or workmanship. This limited warranty does not cover damage due to accidents, abuse or improper handling, maintenance or use. This limited warranty also does not cover any engine that has been structurally altered, or when the vehicle has been used in racing competition. This limited warranty also does not cover physical damage, corrosion, or defects caused by fire, explosions or other similar causes beyond the control of CFMOTO Powersports, Inc. Owners are responsible for performing the scheduled maintenance identified in the owner's manual. CFMOTO Powersports, Inc. may deny warranty claims for failures that have been caused by the owner's or operator's improper maintenance or use, by accidents for which CFMOTO Powersports, Inc. has no responsibility, or by acts of God. Any qualified repair shop or person may maintain, replace, or repair the emission control devices or systems on your vehicle. CFMOTO Powersports, Inc. recommends that you contact an authorized CFMOTO Powersports, Inc. dealer to perform any service that may be necessary for your vehicle. CFMOTO Powersports, Inc. also recommends that you use only genuine CFMOTO Powersports, Inc. parts. It is a potential violation of the Clean Air Act if a part supplied by an aftermarket parts manufacturer reduces the effectiveness of the vehicle's emission controls. Tampering with emission controls is prohibited by federal law. If you have any questions regarding your warranty rights and responsibilities, please contact CFMOTO Powersports, Inc. at 888-823-6686.

## WARRANTY INFORMATION FOR USA

### Noise Control System and Tampering

Warranty time period: 1,865 miles (3000 km)

Federal law prohibits the following acts or causing thereof:

(1) The removal or rendering inoperative by any person other than for purposes of maintenance, repair, or replacement, of any device or element of design incorporated into any new vehicle for the purpose of noise control prior to its sale or delivery to the ultimate purchaser or while it is in use or;

(2) The use of the vehicle after such device or element of design has been removed or rendered inoperative by any person.

AMONG THOSE ACTS PRESUMED TO CONSTITUTE TAMPERING ARE THE ACTS LISTED BELOW:

These acts include tampering with the following systems; i.e., modification, removal, etc.

#### **Exhaust system**

- Muffler
- Exhaust
- Silencer

#### **Intake system**

- Air cleaner case
- Air cleaner element
- Intake duct

**▲ WARNING**

Improper ATV use can result in SEVERE INJURY or DEATH.





ALWAYS USE AN APPROVED HELMET AND PROTECTIVE GEAR

NEVER USE ON PUBLIC ROADS

NEVER CARRY PASSENGERS

NEVER USE WITH DRUGS OR ALCOHOL

**NEVER** operate :

- without proper training or instruction.
- at speeds too fast for your skills or the conditions.
- on public roads - a collision can occur with another vehicle.
- with a passenger - passengers affect balance and steering and increase risk of losing control.

**ALWAYS** :

- use proper riding techniques to avoid vehicle overturns on hills and rough terrain and in turns.
- avoid paved surfaces - pavement may seriously affect handling and control.

LOCATE AND READ OWNER'S MANUAL.  
FOLLOW ALL INSTRUCTIONS AND WARNINGS.

TYPE I

**▲ WARNING**

Improper use can result in SEVERE INJURY or DEATH





ALWAYS USE AN APPROVED HELMET AND PROTECTIVE GEAR FOR DRIVER AND PASSENGER

NEVER USE ON PUBLIC ROADS

NEVER CARRY MORE THAN 1 PASSENGER

NEVER USE WITH DRUGS OR ALCOHOL

**NEVER** operate :

- without proper ATV training or instruction.
- at speeds too fast for your skills or the conditions.
- on public roads - a collision can occur with another vehicle.
- with a passenger unless passenger seat is securely in place.

**THE OPERATOR MUST ALWAYS** :

- use proper riding techniques to avoid overturns on hills and rough terrain and in turns
- avoid paved surfaces - pavement may seriously affect handling and control
- reduce speed and use extra caution at all times when carrying a passenger - dismount passenger when conditions require
- make sure passenger reads and understands this label and passenger safety label

LOCATE AND READ OPERATOR'S MANUAL.  
FOLLOW ALL INSTRUCTIONS AND WARNINGS

TYPE II



**CFMOTO**

**MANUFACTURED BY:  
ZHEJIANG CFMOTO POWER CO., LTD.**

No.116,Wuzhou Road,Yuhang Economic Development Zone, Hangzhou 311100,Zhejiang Province  
Tel:86-571-89265799 Fax:86-571-89265788  
E-mail: service@cfmoto.com www.cfmoto.cn

**DISTRIBUTED BY:  
CFMOTO POWERSPORTS INC**

3555 Holly Lane N. Suite#30,Plymouth,MN55447,USA  
Toll free:(888)8-CFMOTO(823-6686)  
Tel:(1)763-398-2690 Fax:(1763-398-2695)  
www.cfmotousa.com

**DISTRIBUTED BY  
CANADA MOTOR IMPORT INC.**

24 rue Industrielle, Saint-Benoît Labre,  
Québec, Canada, G0M 1P0  
Tel:418-227-2077  
www.cfmoto.ca